

UK X11 + HE2311 ASAHI

Insert bearings

TYPE: Ball bearings, Radial insert bearings, With adapter sleeve, Spherical outer ring, Series UK X, seals on both side, inch size

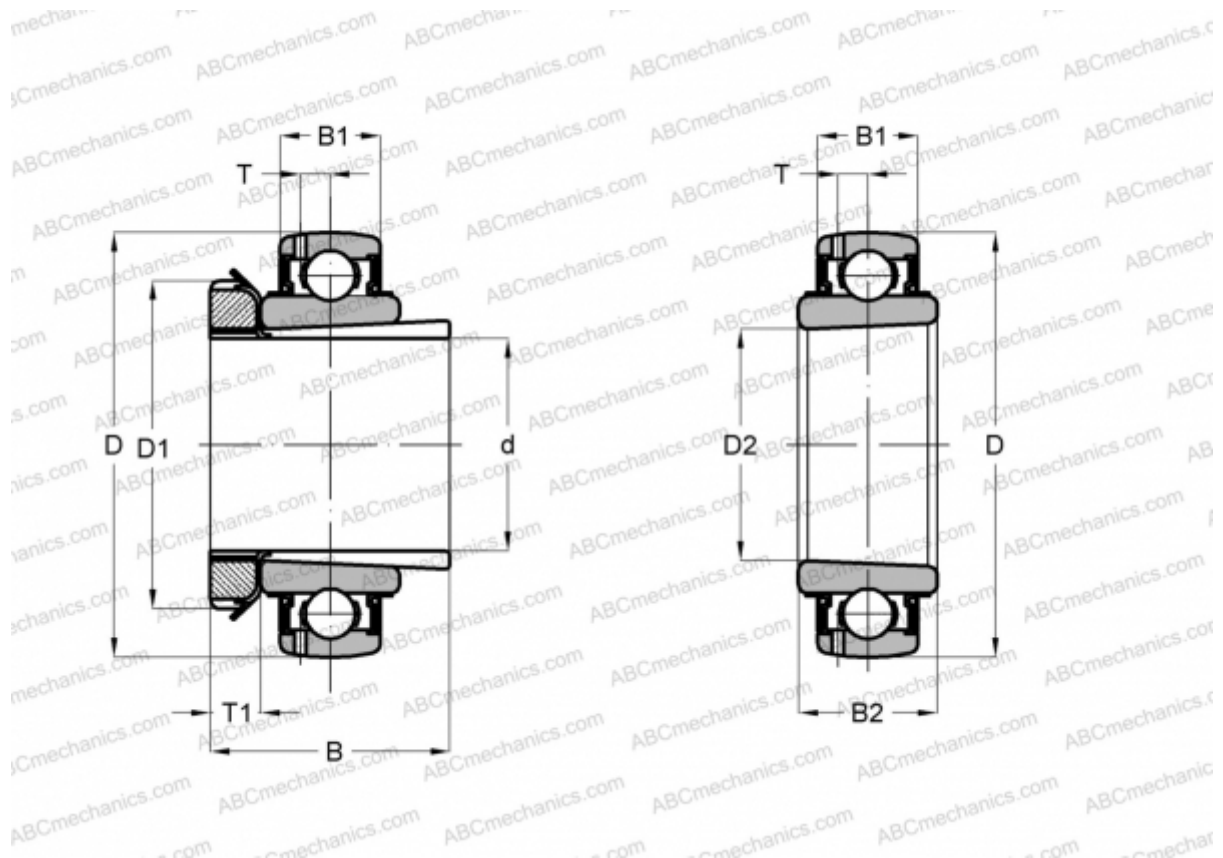

Technical specification

DIMENSIONS, MM

d	50,800
D	110,000
D1	75,006
D2	55,001
B	59,004
B1	26,010
B2	35,992
T	7,696
T1	11,989

WEIGHT, KG 1,538

MANUFACTURER [ASAHI](#)