

## UK X12 + HA2312 ASAHI

Insert bearings

TYPE: Ball bearings, Radial insert bearings, With adapter sleeve, Spherical outer ring, Series UK X, seals on both side, inch size

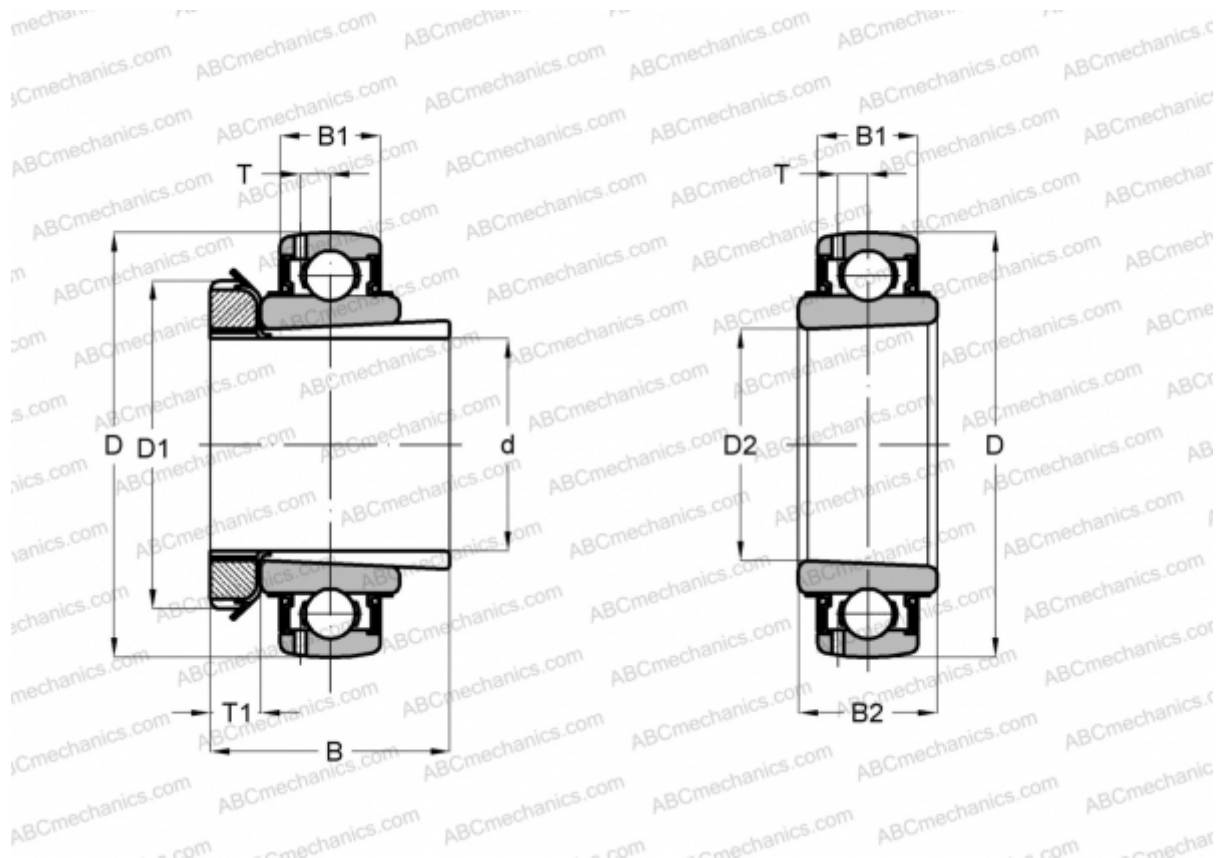

### Technical specification

#### DIMENSIONS, MM

d	52,387
D	120,000
D1	80,010
D2	60,000
B	62,001
B1	27,000
B2	37,998
T	8,306
T1	13,005

**WEIGHT, KG** 1,891

**MANUFACTURER** [ASAHI](#)