

UK X12 + HS2312 ASAHI

Insert bearings

TYPE: Ball bearings, Radial insert bearings, With adapter sleeve, Spherical outer ring, Series UK X, seals on both side, inch size

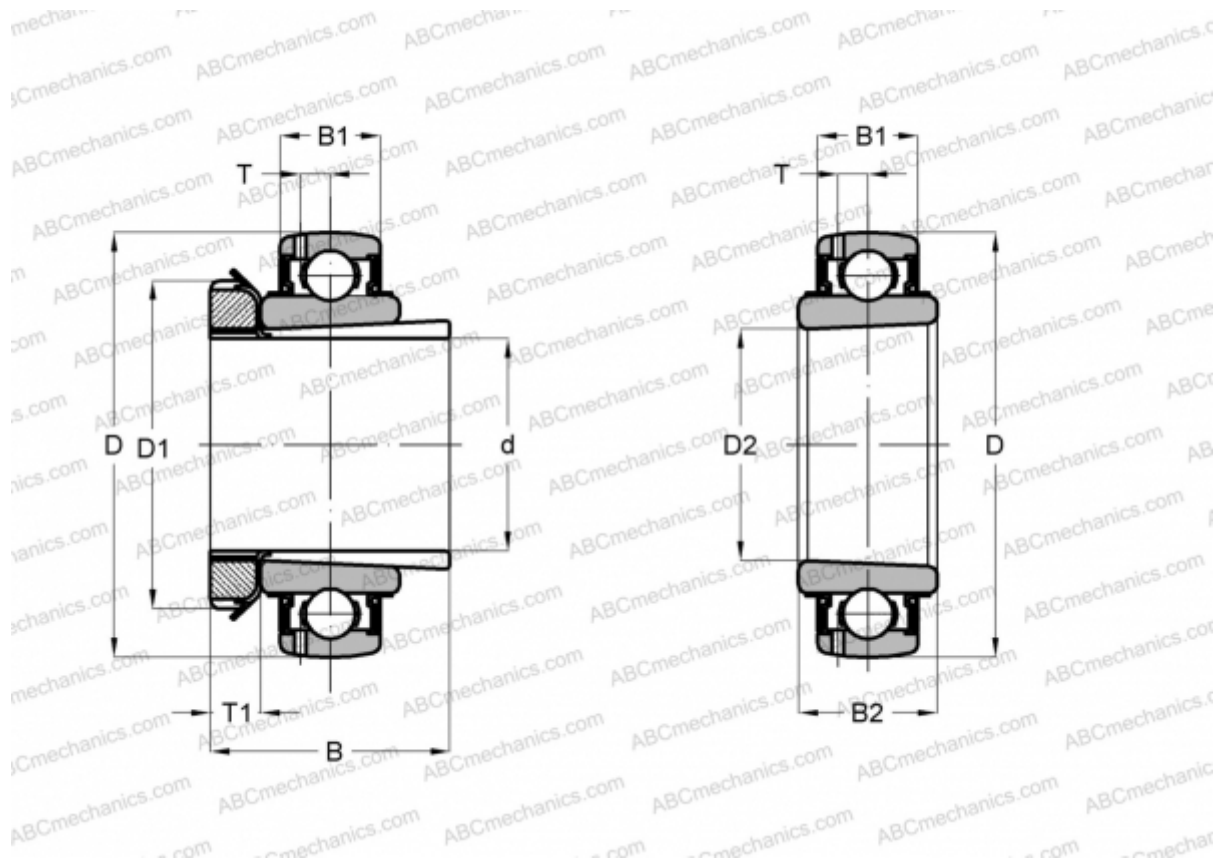

Technical specification

DIMENSIONS, MM

d	53,975
D	120,000
D1	80,010
D2	60,000
B	62,001
B1	27,000
B2	37,998
T	8,306
T1	13,005

WEIGHT, KG 1,891

MANUFACTURER [ASAHI](#)