

UK X13 + HE2313 ASAHI

Insert bearings

TYPE: Ball bearings, Radial insert bearings, With adapter sleeve, Spherical outer ring, Series UK X, seals on both side, inch size

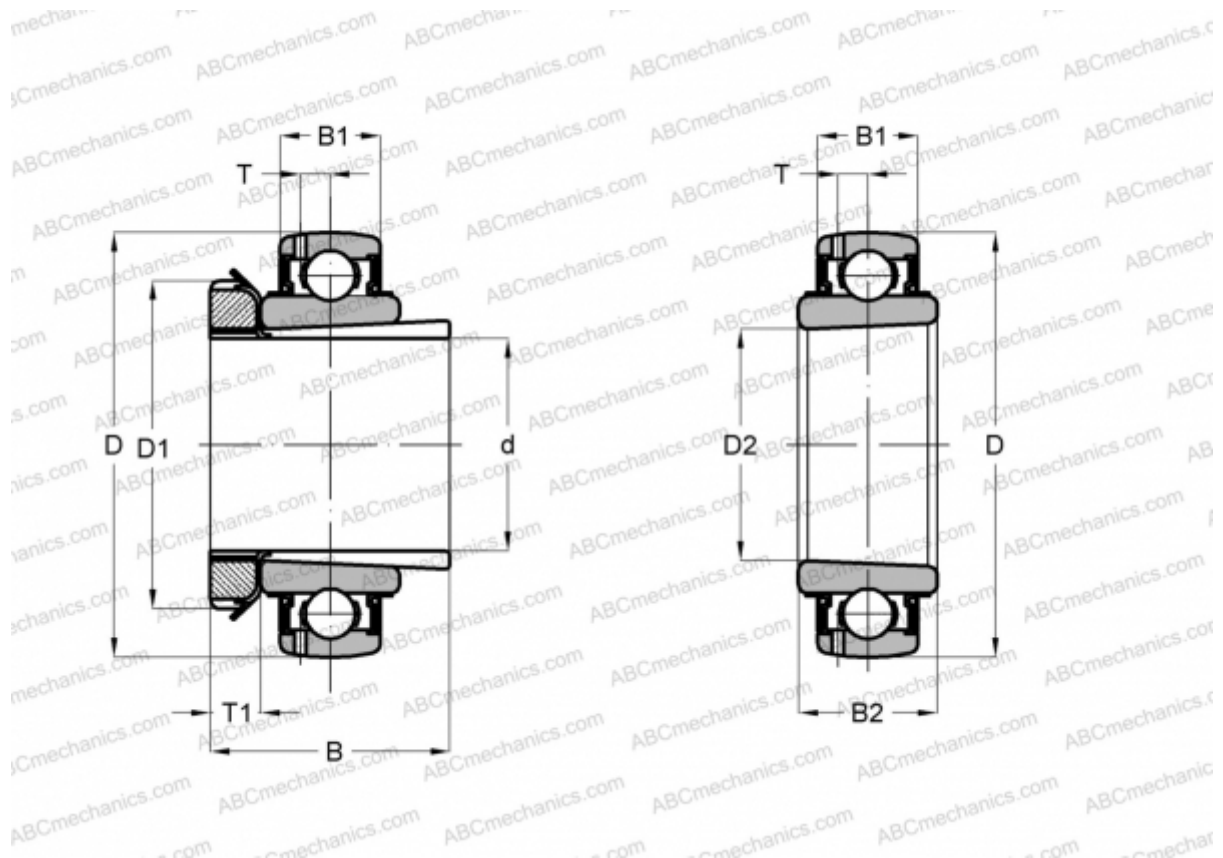

Technical specification

DIMENSIONS, MM

d	57,150
D	125,001
D1	84,988
D2	65,001
B	64,999
B1	29,007
B2	40,005
T	8,712
T1	13,995

WEIGHT, KG 2,091

MANUFACTURER [ASAHI](#)