

## UK X15 + HE2315 ASAHI

Insert bearings

TYPE: Ball bearings, Radial insert bearings, With adapter sleeve, Spherical outer ring, Series UK X, seals on both side, inch size

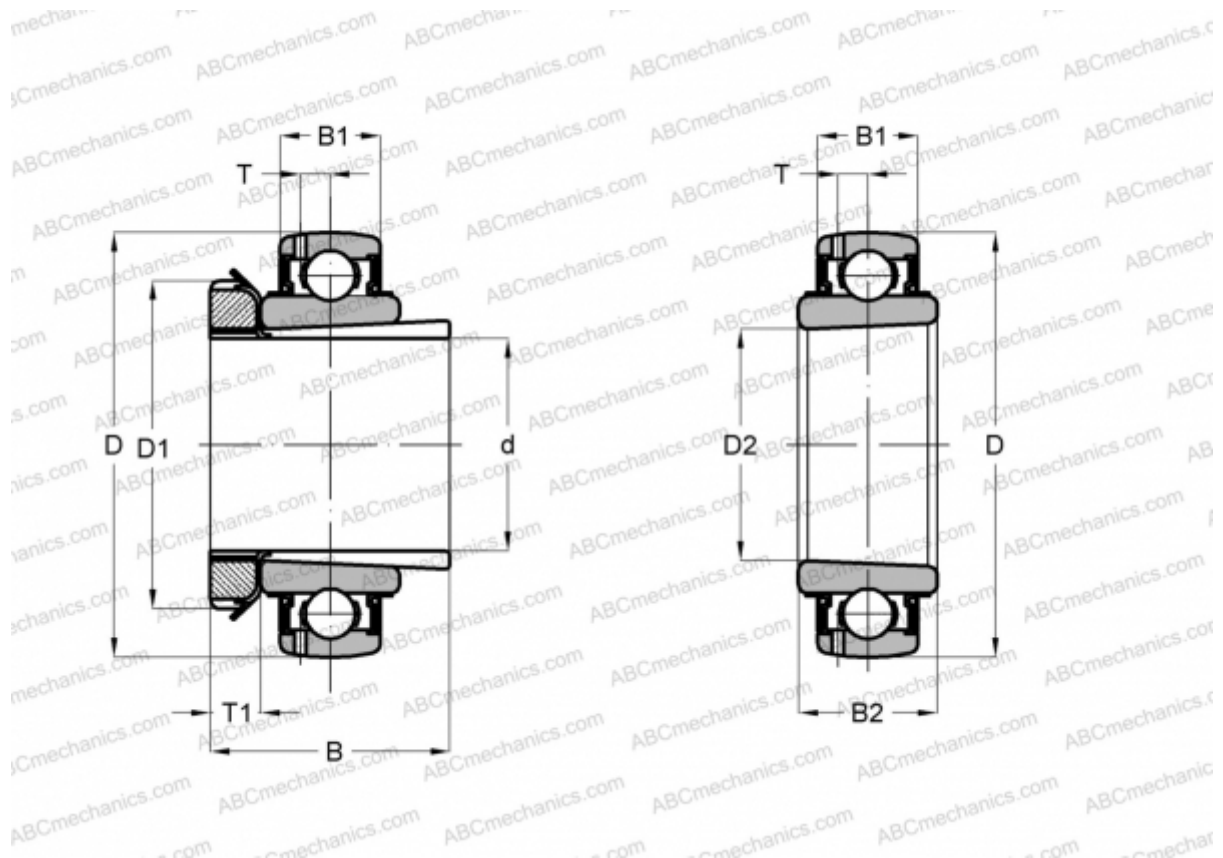

### Technical specification

#### DIMENSIONS, MM

d	63,500
D	140,000
D1	97,993
D2	75,001
B	73,000
B1	32,004
B2	43,993
T	9,601
T1	15,011

**WEIGHT, KG** 3,248

**MANUFACTURER** [ASAHI](#)