

GLE25-KRR-B INA

Insert bearings

TYPE: Ball bearings, Radial insert bearings, With drive slot, Spherical outer ring, Series GLE..-KRR-B(INA), seals on both side

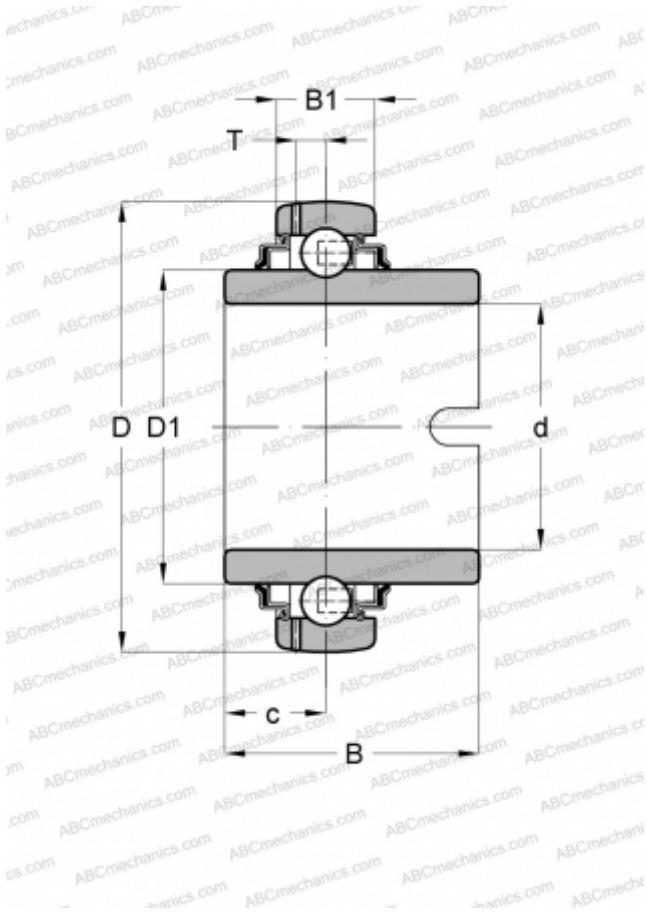

Technical specification

DIMENSIONS, MM

d	25,000
D	52,000
D1	33,800
B	34,900
B1	15,000
c	14,700
T	3,900

WEIGHT, KG

0,190

MANUFACTURER

[INA](#)

REPLACES

GLE25-XL-KRR-B