

GLE30-KRR-B INA

Insert bearings

TYPE: Ball bearings, Radial insert bearings, With drive slot, Spherical outer ring, Series GLE..-KRR-B(INA), seals on both side

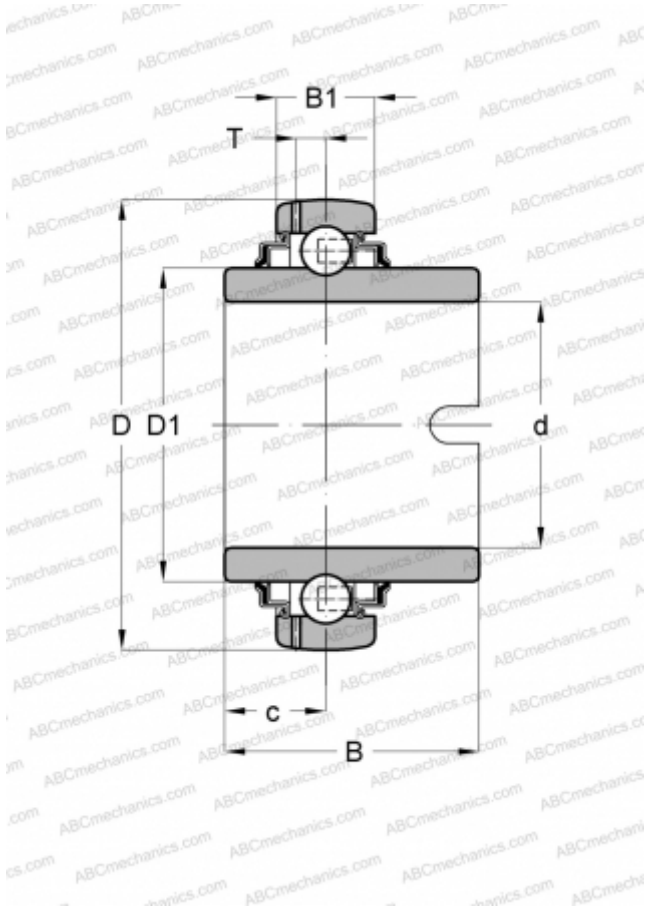

Technical specification

DIMENSIONS, MM

d	30,000
D	62,000
D1	40,200
B	36,500
B1	18,000
c	14,500
T	4,700

WEIGHT, KG

0,300

MANUFACTURER

[INA](#)

REPLACES

GLE30-XL-KRR-B