

GLE40-KRR-B INA

Insert bearings

TYPE: Ball bearings, Radial insert bearings, With drive slot, Spherical outer ring, Series GLE..-KRR-B(INA), seals on both side

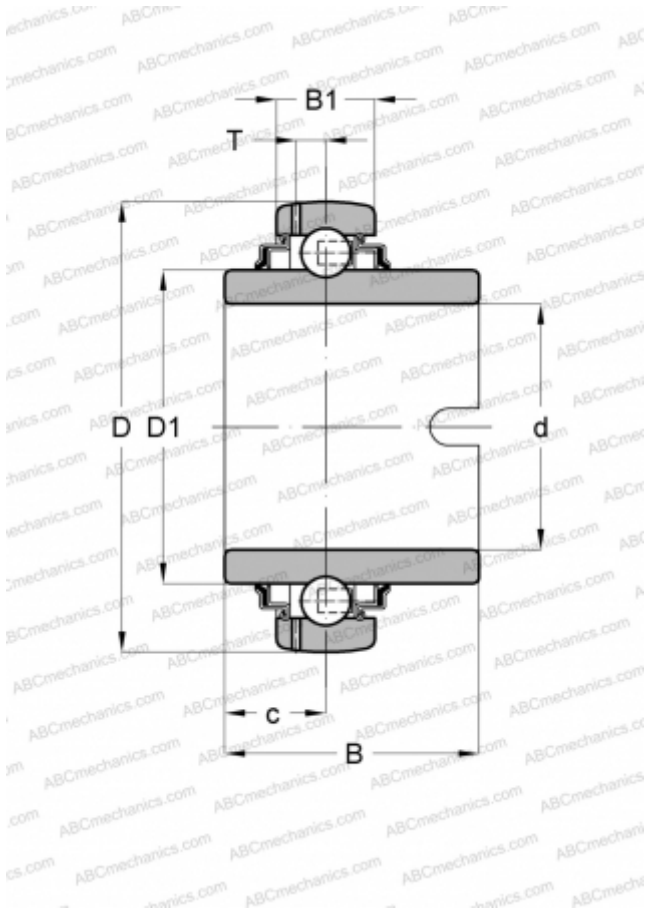

Technical specification

DIMENSIONS, MM

d	40,000
D	80,000
D1	52,300
B	42,900
B1	21,000
c	15,900
T	6,400

WEIGHT, KG

0,570

MANUFACTURER

[INA](#)

REPLACES

GLE40-XL-KRR-B