

RABRB20/52-FA106 INA

Insert bearings

TYPE: Ball bearings, Radial insert bearings, Rubber interliner, Eccentric locking collar, series RABRA, RABRB(INA), seals on both side

Technical specification

DIMENSIONS, MM

d	20,000
D	52,300
D1	33,000
D2	39,000
B	32,300
B1	17,600
B2	31,000
c	23,500

WEIGHT, KG

0,200

MANUFACTURER

[INA](#)

REPLACES

RABRB20/52-XL-FA106

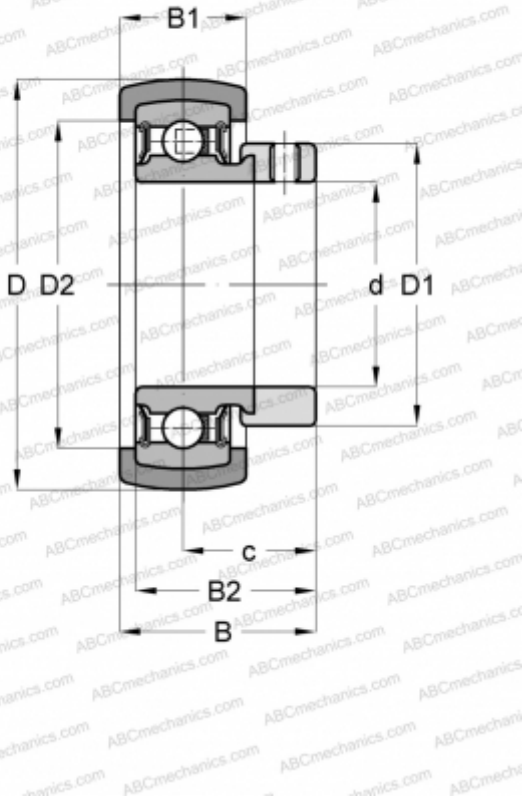

ASSOCIATED PRODUCTS

RAE20-NPP-B-FA106