

RABRB25/62-FA106 INA

Insert bearings

TYPE: Ball bearings, Radial insert bearings, Rubber interliner, Eccentric locking collar, series RABRA, RABRB(INA), seals on both side

Technical specification

DIMENSIONS, MM

d	25,000
D	62,200
D1	37,500
D2	44,500
B	33,900
B1	20,800
B2	31,000
c	23,500

WEIGHT, KG

0,240

MANUFACTURER

[INA](#)

REPLACES

RABRB25/62-XL-FA106

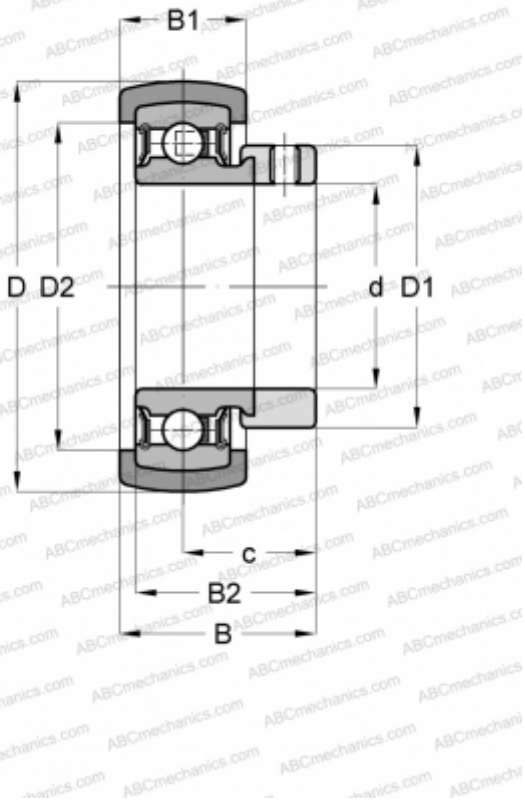

ASSOCIATED PRODUCTS

RAE25-NPP-B-FA106