

## BE25 INA

Insert bearings

TYPE: Ball bearings, Radial insert bearings, With steel aligning ring, Cylindrical outer ring, series BE(INA), seals on both side

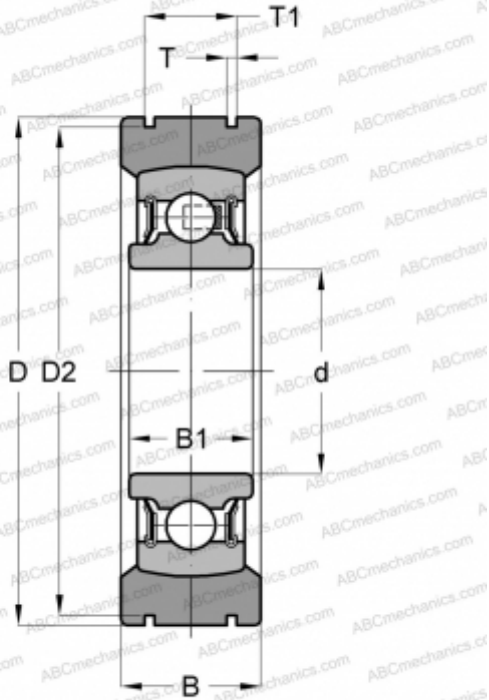

### Technical specification

#### DIMENSIONS, MM

d	25,000
D	62,000
D2	59,600
B	17,000
B1	15,000
T	1,900
T1	11,200
E	205

#### WEIGHT, KG

0,250

#### MANUFACTURER

[INA](#)

#### REPLACES

BE25-XL

#### ASSOCIATED PRODUCTS

205-NPP-B