

## 203-KRR INA

Insert bearings

TYPE: Ball bearings, Radial insert bearings, Wide inner ring, Cylindrical outer ring, Series 2..-KRR, 2..-KRR-AH..(INA), seals on both side

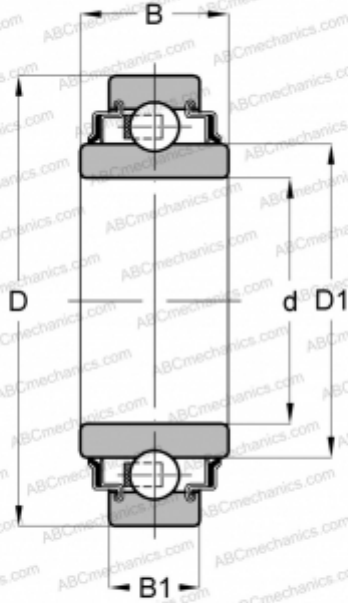

### Technical specification

#### DIMENSIONS, MM

d	17,000
D	40,000
B	18,300
B1	12,000

#### WEIGHT, KG

0,070

#### MANUFACTURER

[INA](#)

#### REPLACES

203-XL-KRR