

206-KRR INA

Insert bearings

TYPE: Ball bearings, Radial insert bearings, Wide inner ring, Cylindrical outer ring, Series 2..-KRR, 2..-KRR-AH..(INA), seals on both side

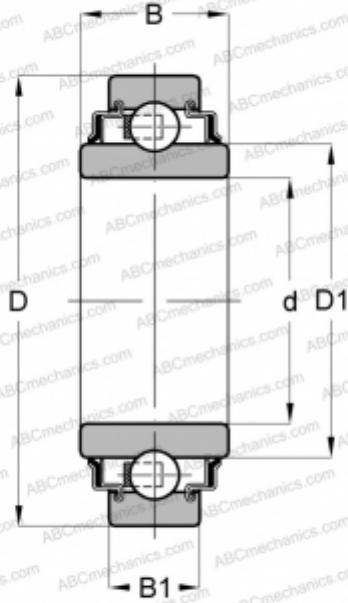

Technical specification

DIMENSIONS, MM

d	30,000
D	62,000
B	24,000
B1	16,000

WEIGHT, KG

0,240

MANUFACTURER

[INA](#)

REPLACES

206-XL-KRR