

## 208-KRR-AH04 INA

Insert bearings

TYPE: Ball bearings, Radial insert bearings, Wide inner ring, Cylindrical outer ring, Series 2...KRR, 2...KRR-AH..(INA), seals on both side

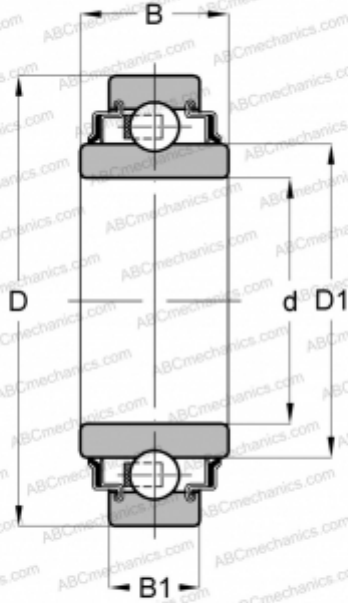

### Technical specification

#### DIMENSIONS, MM

d	38,892
D	80,000
B	27,500
B1	21,000

#### WEIGHT, KG

0,480

#### MANUFACTURER

[INA](#)

#### REPLACES

208-XL-KRR-AH04