

GVK100-208-KTT-B-AS2/V INA

Insert bearings

TYPE: Ball bearings, Radial insert bearings, Self-aligning, Spherical outer ring, Series GVK(E)..-KTT-B(INA), seals on both side, inner ring with square bore

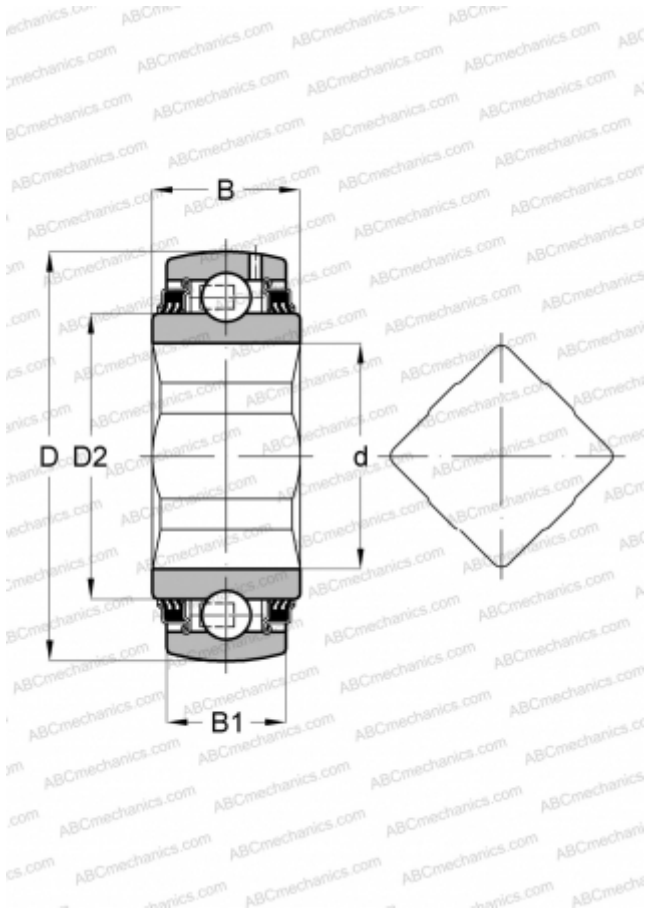

Technical specification

DIMENSIONS, MM

d	25,400
D	80,000
D2	52,300
B	36,500
B1	21,000

WEIGHT, KG

0,740

MANUFACTURER

[INA](#)