

GVK104-209-KTT-B-AS2/V INA

Insert bearings

TYPE: Ball bearings, Radial insert bearings, Self-aligning, Spherical outer ring, Series GVK(E)..-KTT-B(INA), seals on both side, inner ring with square bore

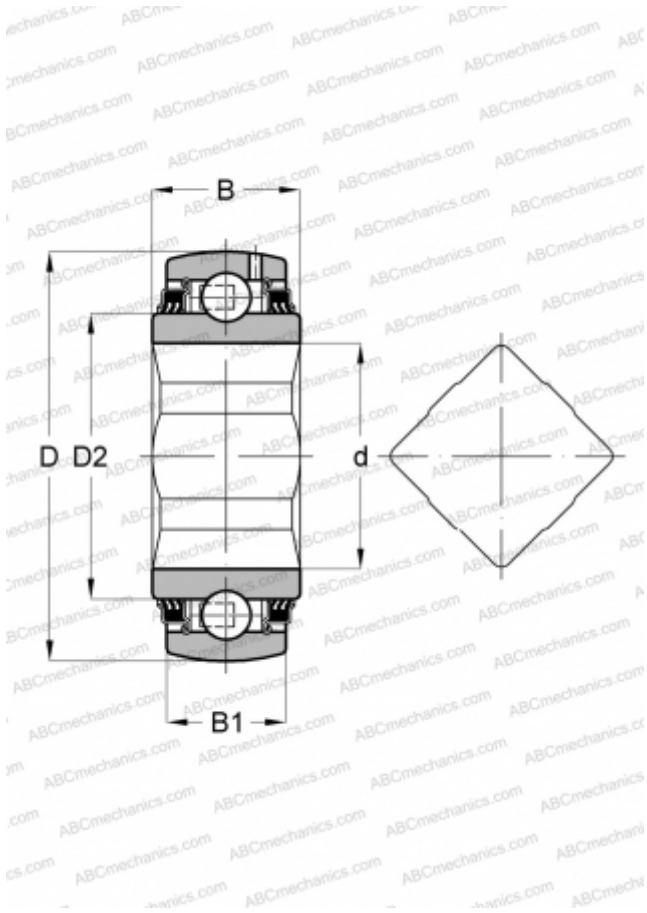

Technical specification

DIMENSIONS, MM

d	31,750
D	85,000
D2	57,900
B	36,500
B1	22,000

WEIGHT, KG

0,710

MANUFACTURER

[INA](#)