

KLRU08X28X11-2Z INA

Track rollers

TYPE: Ball bearings, Track rollers, Single row, With plastic tyre, sealed on both sides

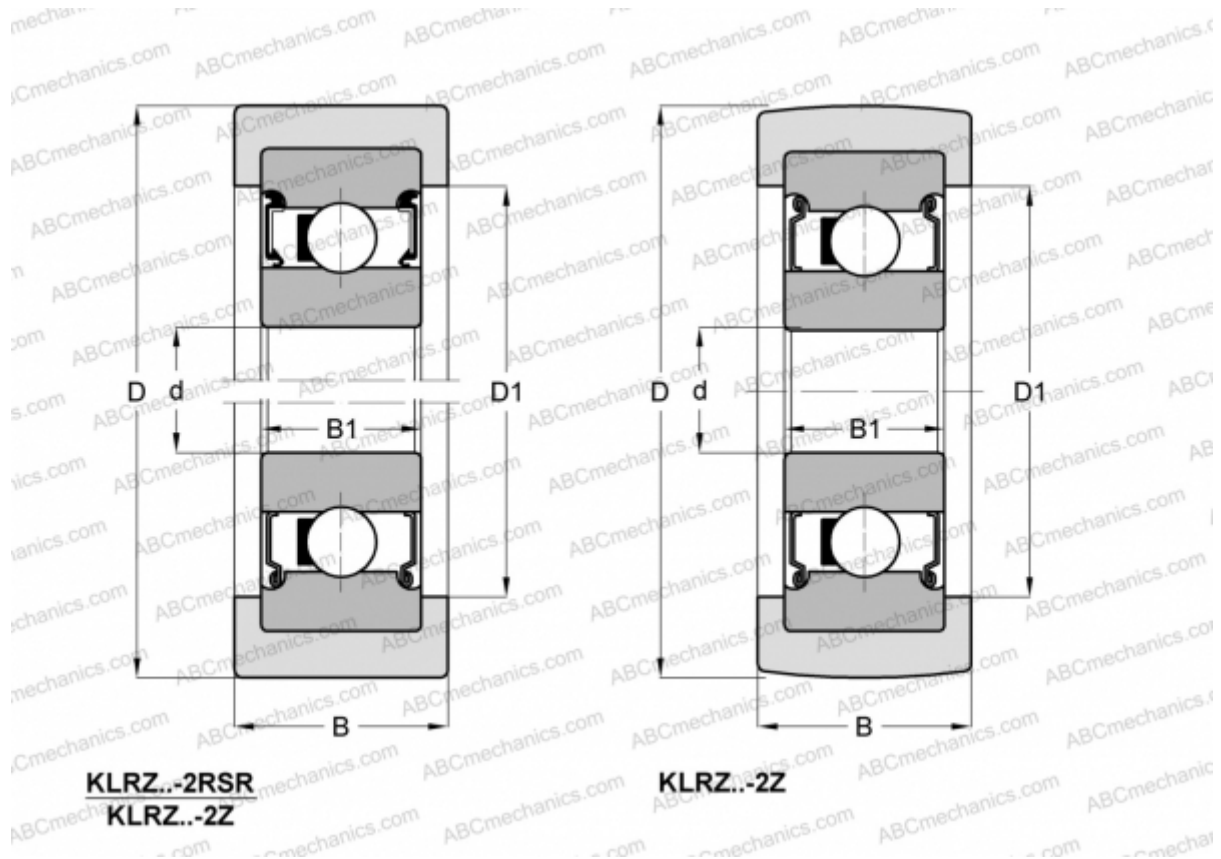

Technical specification

DIMENSIONS, MM

d	8,000
D	27,500
D1	20,000
B	11,000
B1	7,000
E	608

WEIGHT, KG 0,016

MANUFACTURER [INA](#)

ASSOCIATED PRODUCTS

608 2Z