

KLRU12X35X12-2Z INA

Track rollers

TYPE: Ball bearings, Track rollers, Single row, With plastic tyre, sealed on both sides

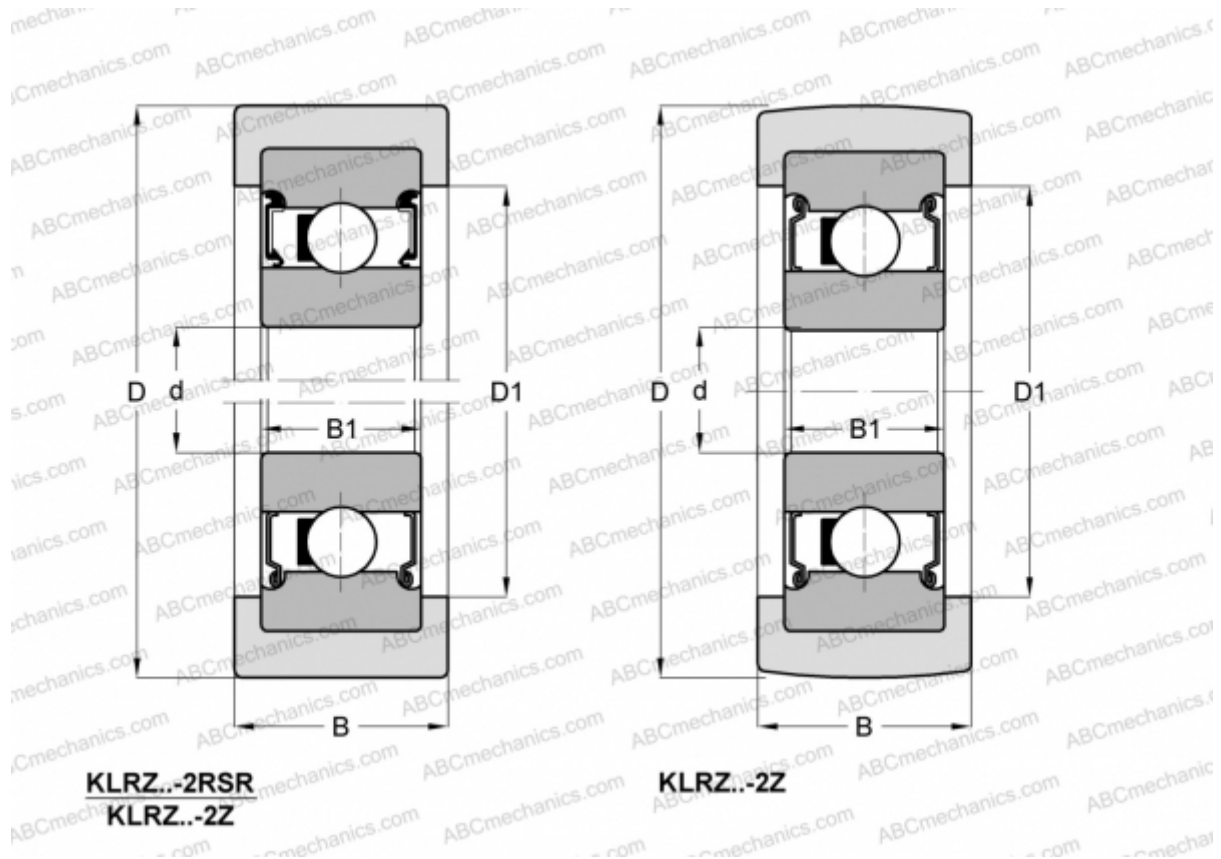

Technical specification

DIMENSIONS, MM

d	12,000
D	34,800
D1	26,000
B	12,000
B1	8,000
E	6001

WEIGHT, KG 0,030

MANUFACTURER [INA](#)

ASSOCIATED PRODUCTS

6001 2Z