

KLRU15X47X20-2Z INA

Track rollers

TYPE: Ball bearings, Track rollers, Single row, With plastic tyre, sealed on both sides

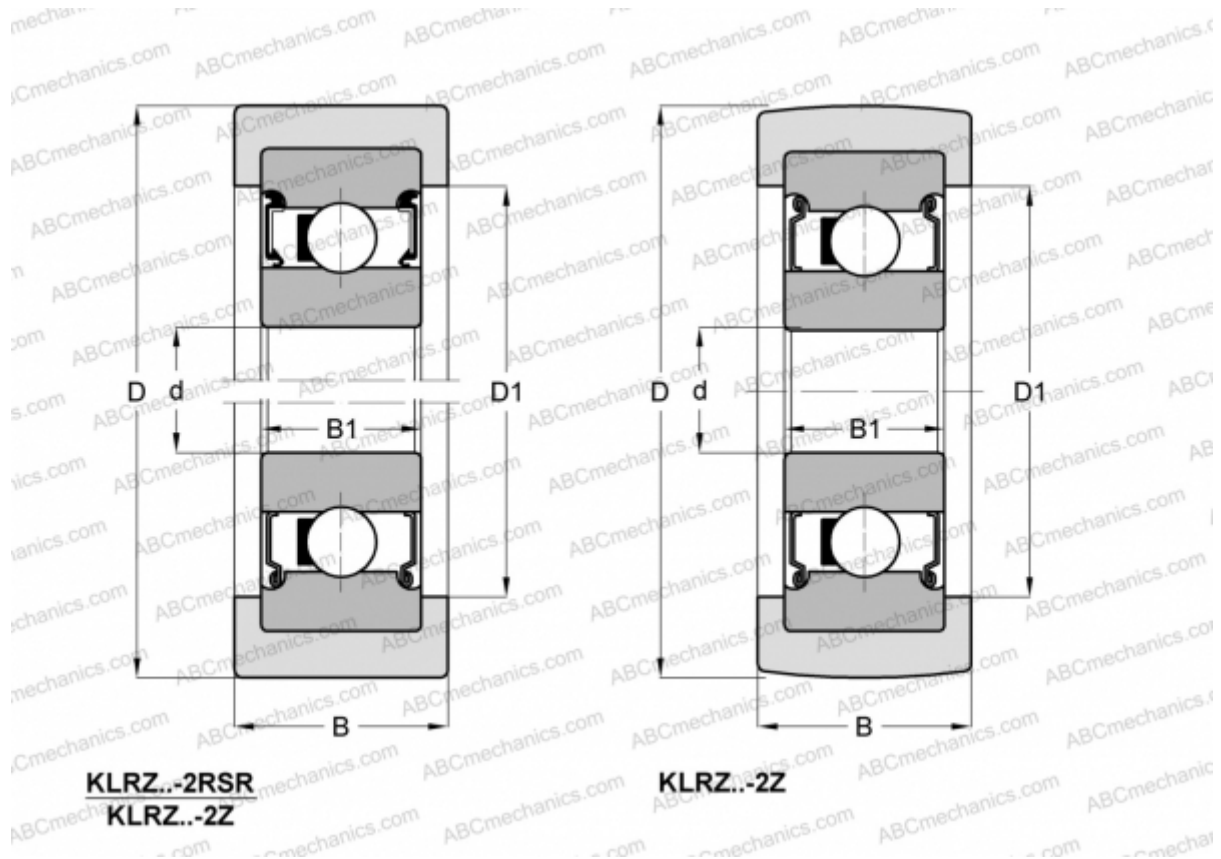

Technical specification

DIMENSIONS, MM

d	15,000
D	46,800
D1	31,500
B	20,000
B1	11,000
E	6202

WEIGHT, KG 0,050

MANUFACTURER [INA](#)

ASSOCIATED PRODUCTS

6202 2Z