

LFR50/5-4-2Z INA

Track rollers

TYPE: Ball bearings, Track rollers, Double row, Profiled, Profile of arrow-shaped arch, gap seals on both sides

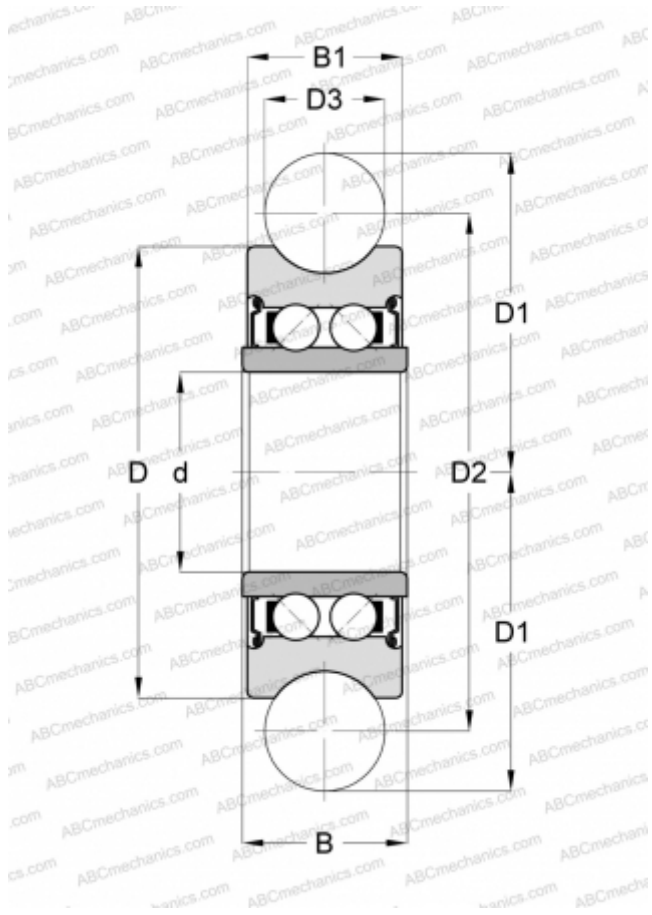

Technical specification

DIMENSIONS, MM

d	5,000
D	16,000
D1	9,000
D2	14,540
D3	4,000
B	8,000
B1	7,000

WEIGHT, KG

0,010

MANUFACTURER

[INA](#)