

LFR50/5-6-2Z INA

Track rollers

TYPE: Ball bearings, Track rollers, Double row, Profiled, Profile of arrow-shaped arch, gap seals on both sides

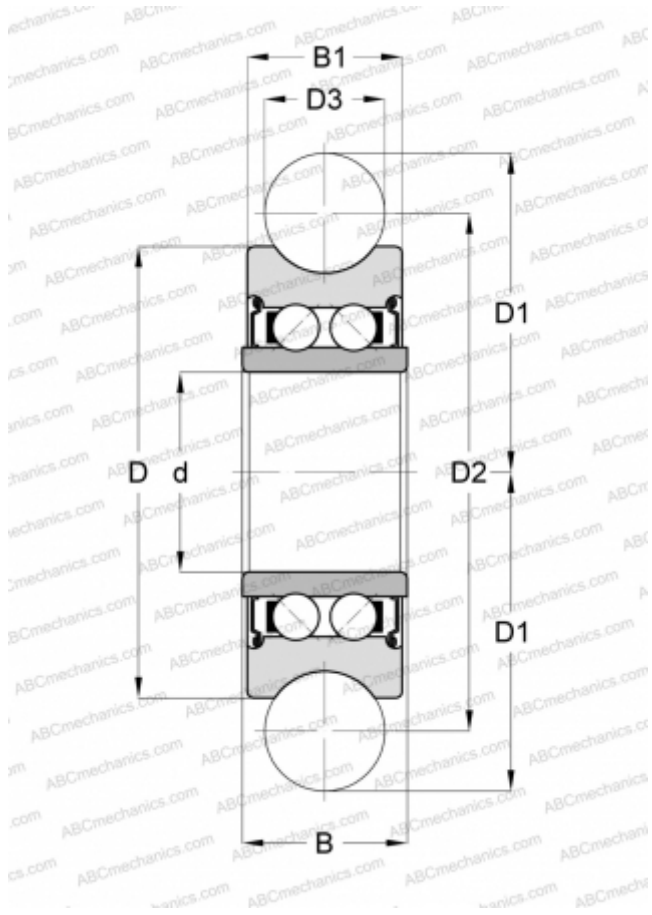

Technical specification

DIMENSIONS, MM

d	5,000
D	17,000
D1	10,500
D2	15,800
D3	6,000
B	8,000
B1	7,000

WEIGHT, KG

0,010

MANUFACTURER

[INA](#)