

LFR5201-10-2Z INA

Track rollers

TYPE: Ball bearings, Track rollers, Double row, Profiled, Profile of arrow-shaped arch, gap seals on both sides

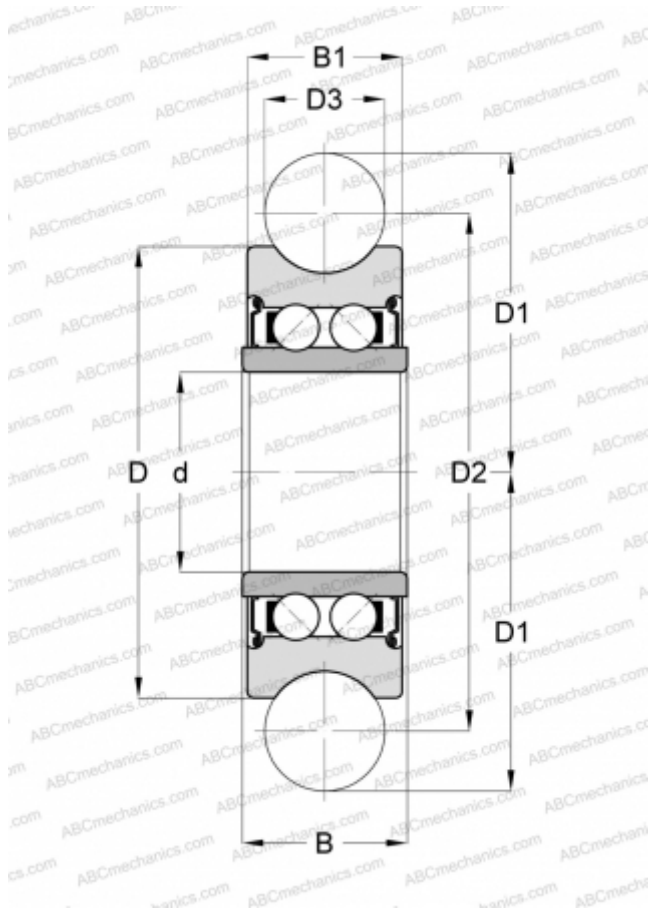

Technical specification

DIMENSIONS, MM

d	12,000
D	35,000
D1	20,650
D2	32,250
D3	10,000
B	15,900
B1	15,900

WEIGHT, KG

0,080

MANUFACTURER

[INA](#)