

## LFR5201-12-2Z INA

Track rollers

TYPE: Ball bearings, Track rollers, Double row, Profiled, Profile of arrow-shaped arch, gap seals on both sides

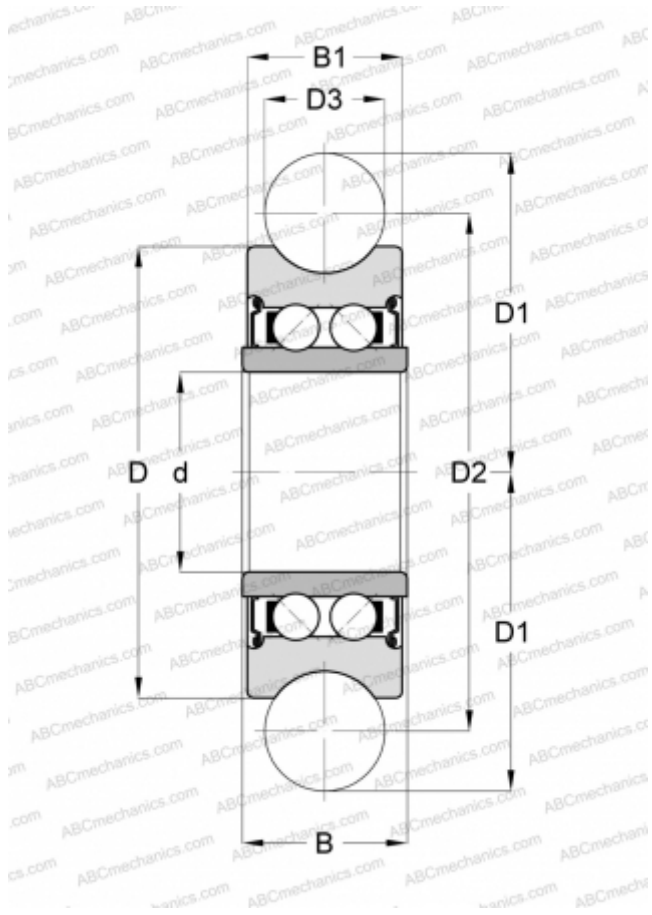

### Technical specification

#### DIMENSIONS, MM

d	12,000
D	35,000
D1	21,750
D2	33,100
D3	12,000
B	15,900
B1	15,900

#### WEIGHT, KG

0,080

#### MANUFACTURER

[INA](#)