

LFR5302-10-2Z INA

Track rollers

TYPE: Ball bearings, Track rollers, Double row, Profiled, Profile of arrow-shaped arch, gap seals on both sides

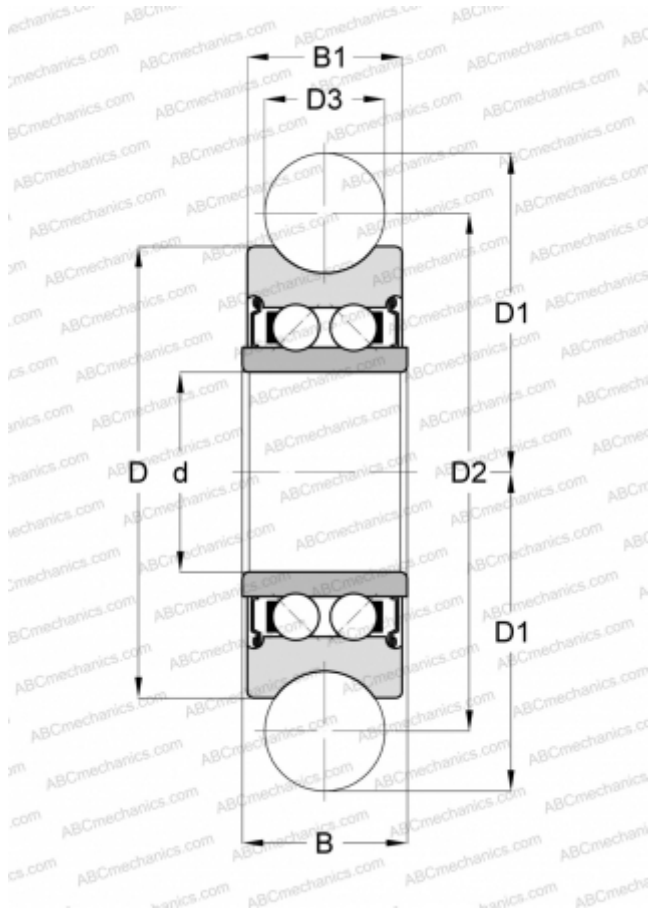

Technical specification

DIMENSIONS, MM

d	15,000
D	47,000
D1	26,650
D2	44,250
D3	10,000
B	19,000
B1	19,000

WEIGHT, KG

0,170

MANUFACTURER

[INA](#)