

LFR5206-25-2Z INA

Track rollers

TYPE: Ball bearings, Track rollers, Double row, Profiled, Profile of arrow-shaped arch, gap seals on both sides

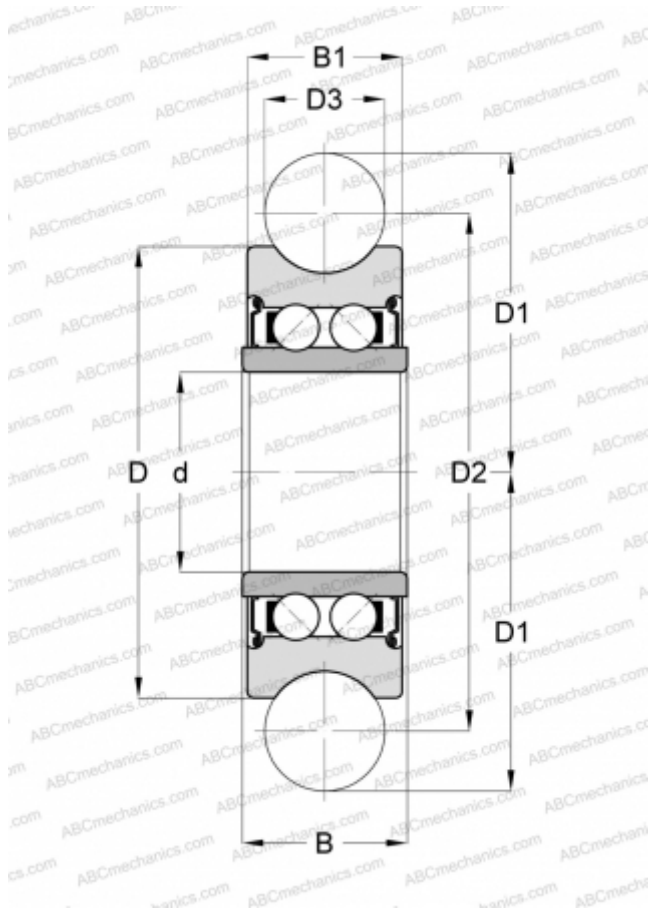

Technical specification

DIMENSIONS, MM

d	25,000
D	72,000
D1	43,500
D2	65,350
D3	25,000
B	25,800
B1	23,800

WEIGHT, KG

0,430

MANUFACTURER

[INA](#)