

LFR5207-30-2Z INA

Track rollers

TYPE: Ball bearings, Track rollers, Double row, Profiled, Profile of arrow-shaped arch, gap seals on both sides

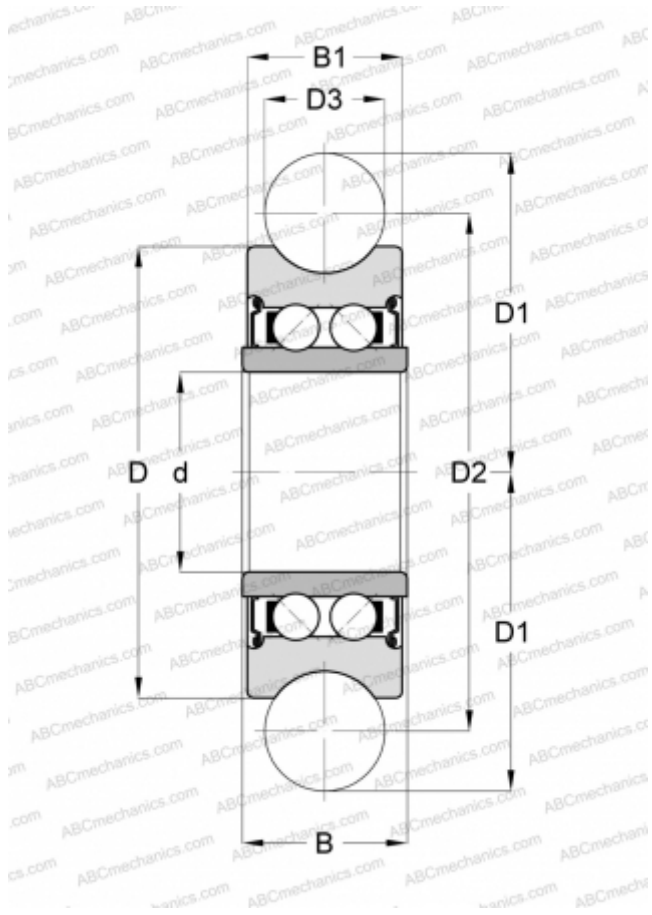

Technical specification

DIMENSIONS, MM

d	30,000
D	80,000
D1	51,000
D2	76,020
D3	30,000
B	29,000
B1	27,000

WEIGHT, KG

0,660

MANUFACTURER

[INA](#)