

RSL183012-A INA

Cylindrical roller bearings

TYPE: Roller bearings, Cylindrical roller bearings, Single row, Without outer ring, Full complement cylindrical roller bearing

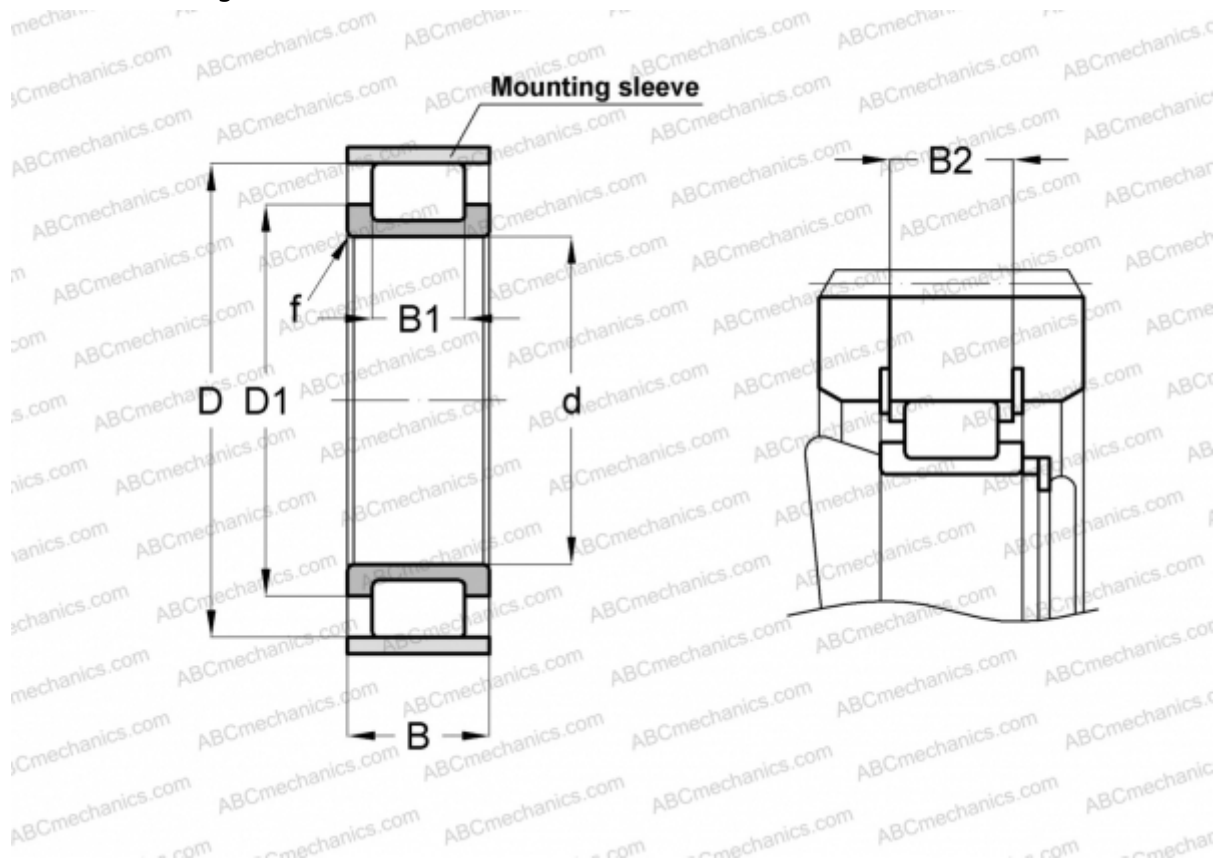

Technical specification

DIMENSIONS, MM

d	60,000
D	86,740
D1	71,700
B	26,000
B1	17,000
B2	22,600
f	1,100

WEIGHT, KG 0,430

MANUFACTURER [INA](#)

ASSOCIATED PRODUCTS

F-88659 + 88X3