

RSL183014-A INA

Cylindrical roller bearings

TYPE: Roller bearings, Cylindrical roller bearings, Single row, Without outer ring, Full complement cylindrical roller bearing

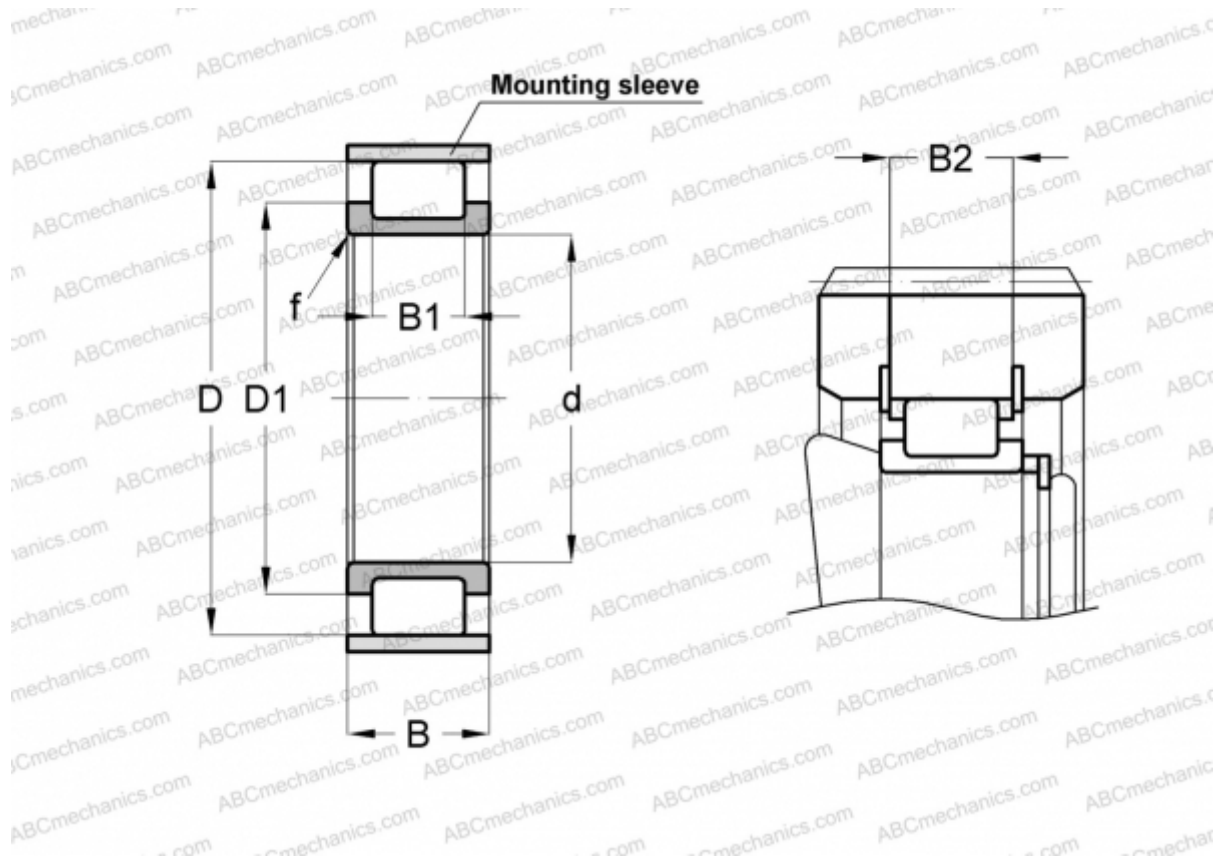

Technical specification

DIMENSIONS, MM

d	70,000
D	100,280
D1	81,500
B	30,000
B1	18,000
B2	26,500
f	1,100

WEIGHT, KG 0,600

MANUFACTURER [INA](#)

ASSOCIATED PRODUCTS

F-88831 + 100X3