

## RSL183017-A INA

Cylindrical roller bearings

TYPE: Roller bearings, Cylindrical roller bearings, Single row, Without outer ring, Full complement cylindrical roller bearing

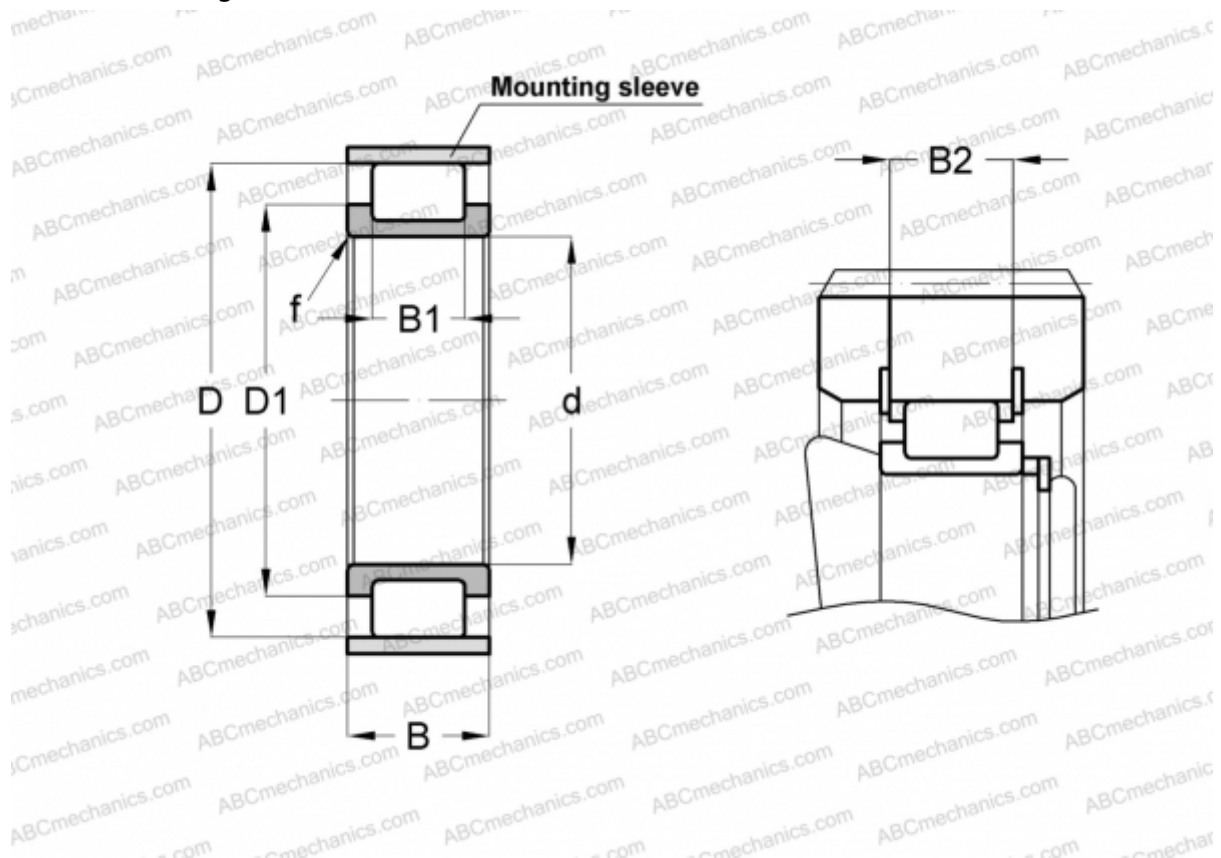

### Technical specification

#### DIMENSIONS, MM

d	85,000
D	121,440
D1	99,500
B	34,000
B1	20,000
B2	29,600
f	1,100

**WEIGHT, KG** 1,000

**MANUFACTURER** [INA](#)

#### ASSOCIATED PRODUCTS

F-91559 + 122X4