

RSL183020-A INA

Cylindrical roller bearings

TYPE: Roller bearings, Cylindrical roller bearings, Single row, Without outer ring, Full complement cylindrical roller bearing

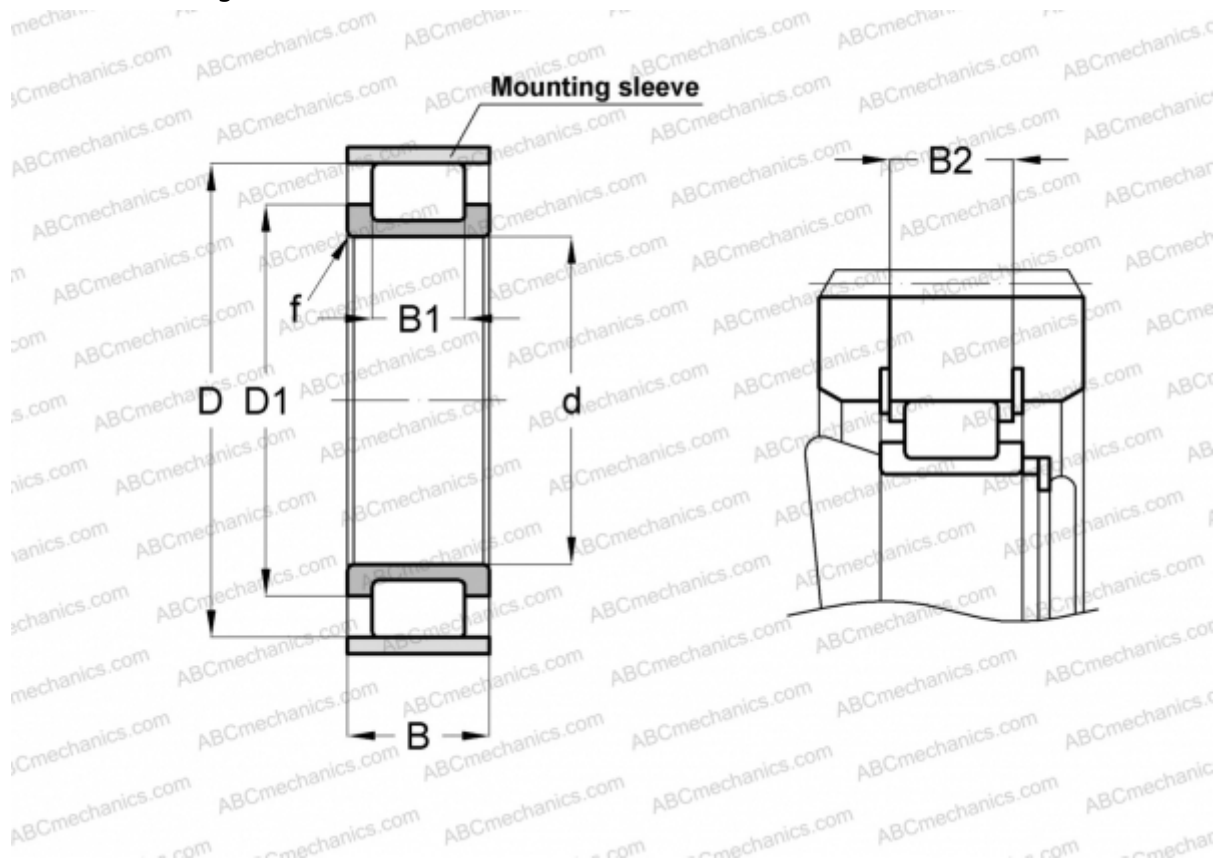

Technical specification

DIMENSIONS, MM

d	100,000
D	139,650
D1	116,000
B	37,000
B1	22,000
B2	32,600
f	1,500

WEIGHT, KG 1,380

MANUFACTURER [INA](#)

ASSOCIATED PRODUCTS

F-91810 + 140X4