

RSL183022-A INA

Cylindrical roller bearings

TYPE: Roller bearings, Cylindrical roller bearings, Single row, Without outer ring, Full complement cylindrical roller bearing

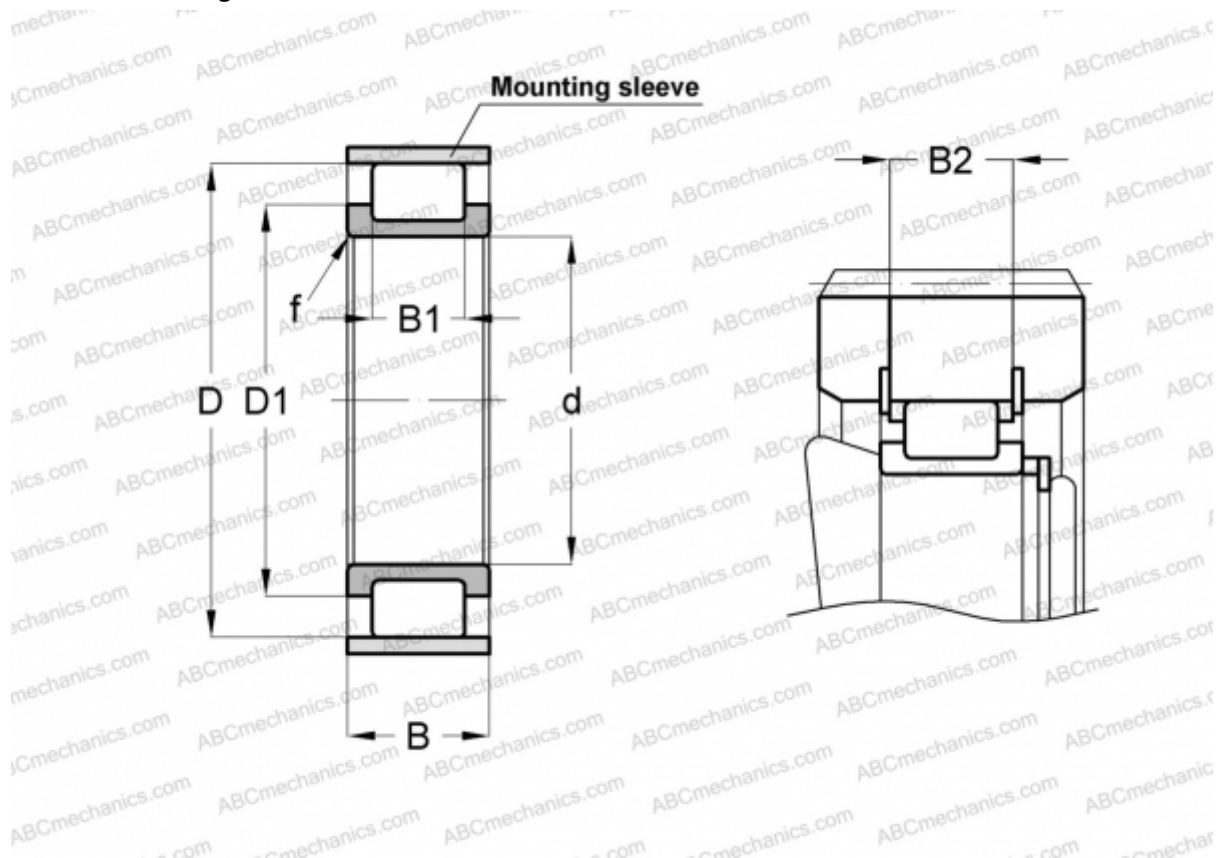

Technical specification

DIMENSIONS, MM

d	110,000
D	156,130
D1	127,500
B	45,000
B1	26,000
B2	40,600
f	2,000

WEIGHT, KG 2,090

MANUFACTURER [INA](#)

ASSOCIATED PRODUCTS

F-91634 + 157X4