

RSL183026-A INA

Cylindrical roller bearings

TYPE: Roller bearings, Cylindrical roller bearings, Single row, Without outer ring, Full complement cylindrical roller bearing

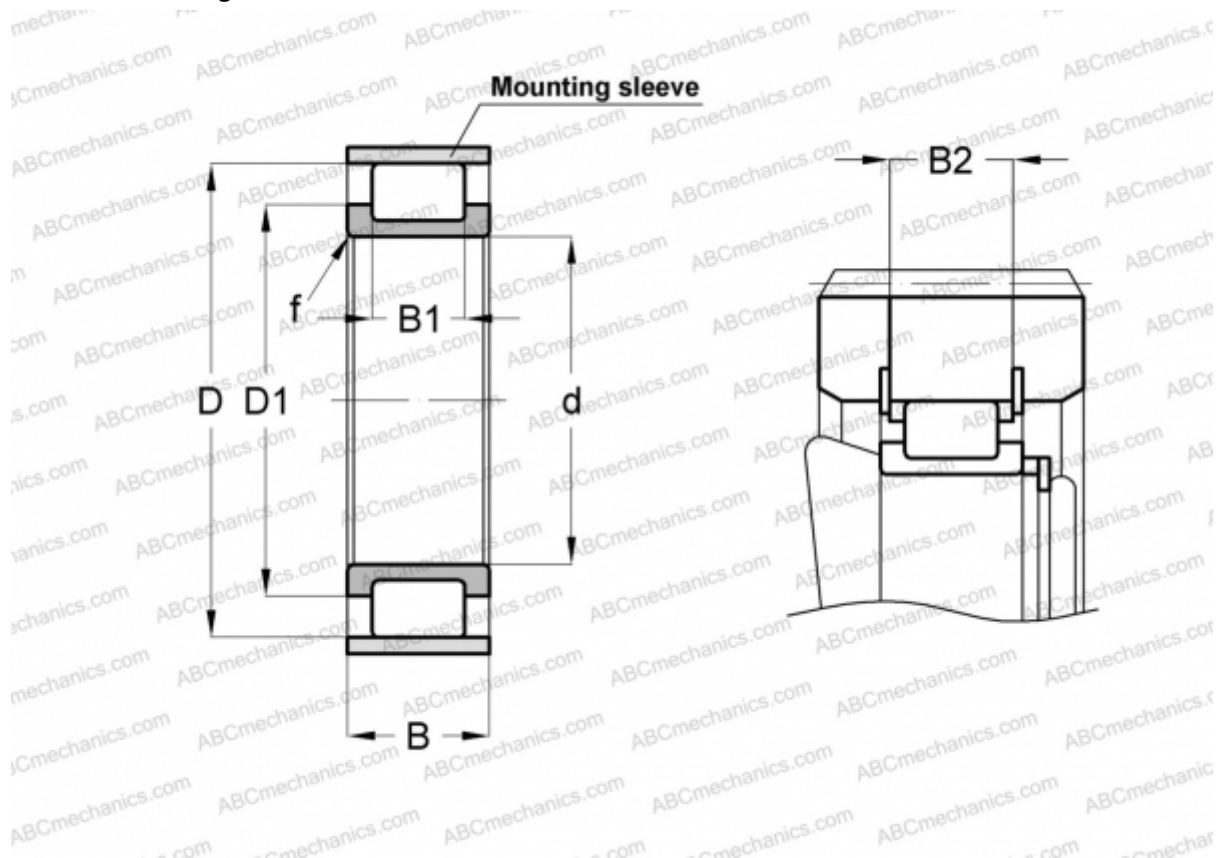

Technical specification

DIMENSIONS, MM

d	130,000
D	183,810
D1	149,000
B	52,000
B1	34,000
B2	47,400
f	2,000

WEIGHT, KG 3,450

MANUFACTURER [INA](#)

ASSOCIATED PRODUCTS

F-91811 + 185X4