

RSL183028-A INA

Cylindrical roller bearings

TYPE: Roller bearings, Cylindrical roller bearings, Single row, Without outer ring, Full complement cylindrical roller bearing

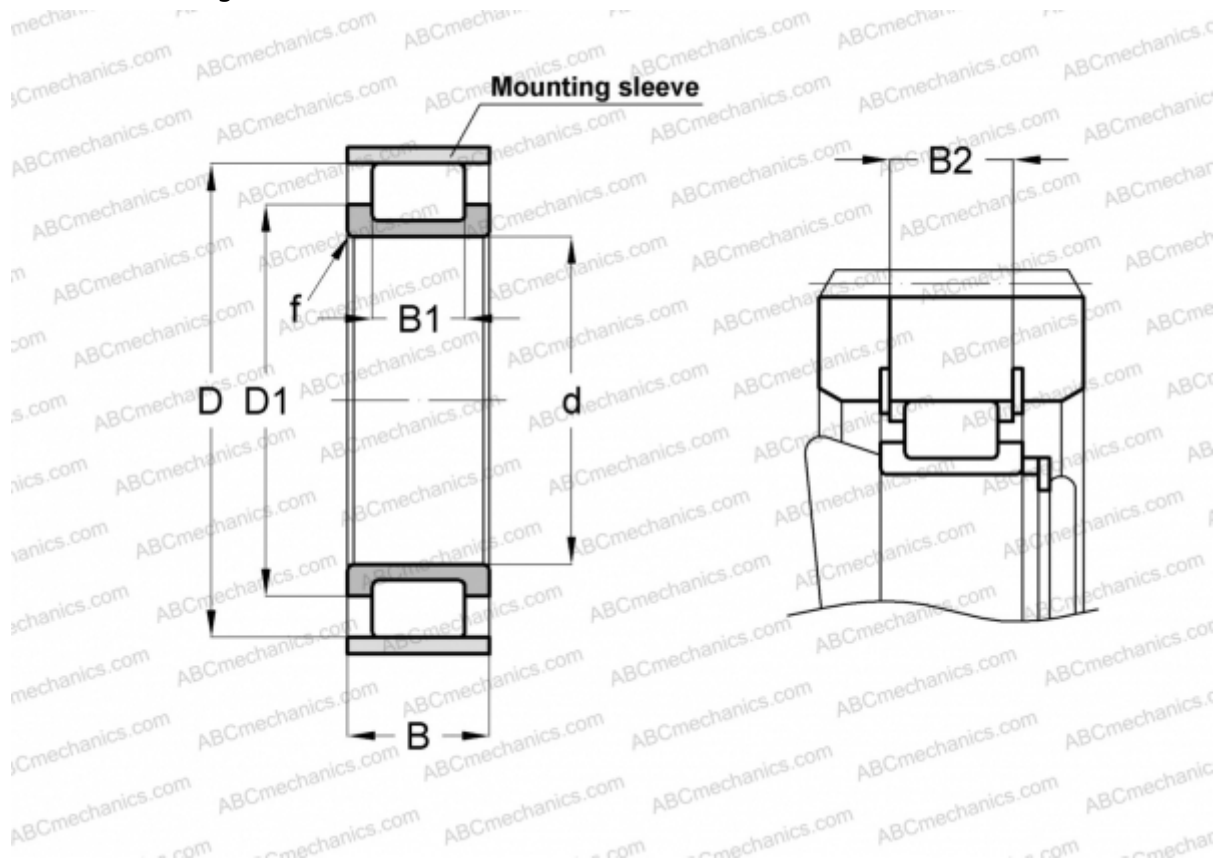

Technical specification

DIMENSIONS, MM

d	140,000
D	197,820
D1	163,000
B	53,000
B1	34,000
B2	48,400
f	2,000

WEIGHT, KG 4,100

MANUFACTURER [INA](#)

ASSOCIATED PRODUCTS

F-91812 + 198X4