

RSL183030-A INA

Cylindrical roller bearings

TYPE: Roller bearings, Cylindrical roller bearings, Single row, Without outer ring, Full complement cylindrical roller bearing

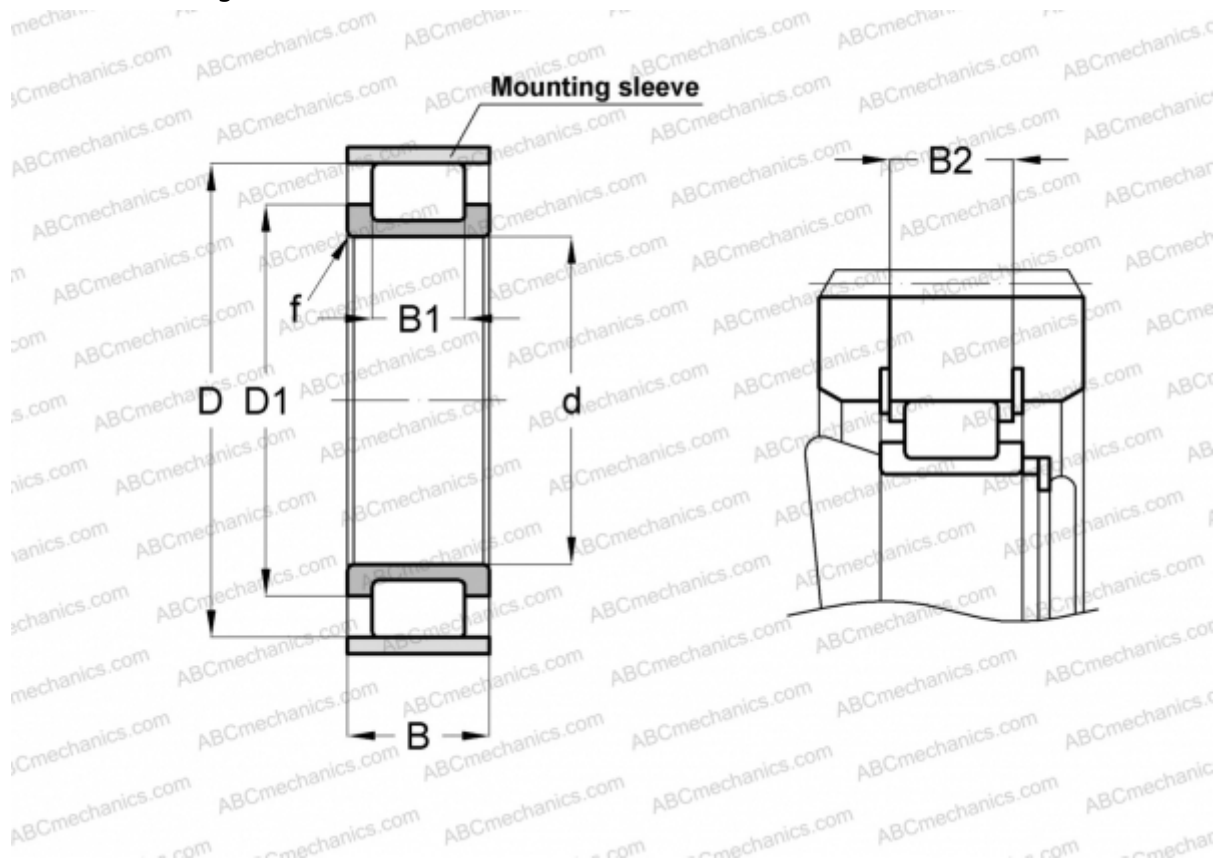

Technical specification

DIMENSIONS, MM

d	150,000
D	206,800
D1	170,500
B	56,000
B1	34,000
B2	50,400
f	2,100

WEIGHT, KG 4,410

MANUFACTURER [INA](#)

ASSOCIATED PRODUCTS

F-91813 + 207X5