

RSL183032-A INA

Cylindrical roller bearings

TYPE: Roller bearings, Cylindrical roller bearings, Single row, Without outer ring, Full complement cylindrical roller bearing

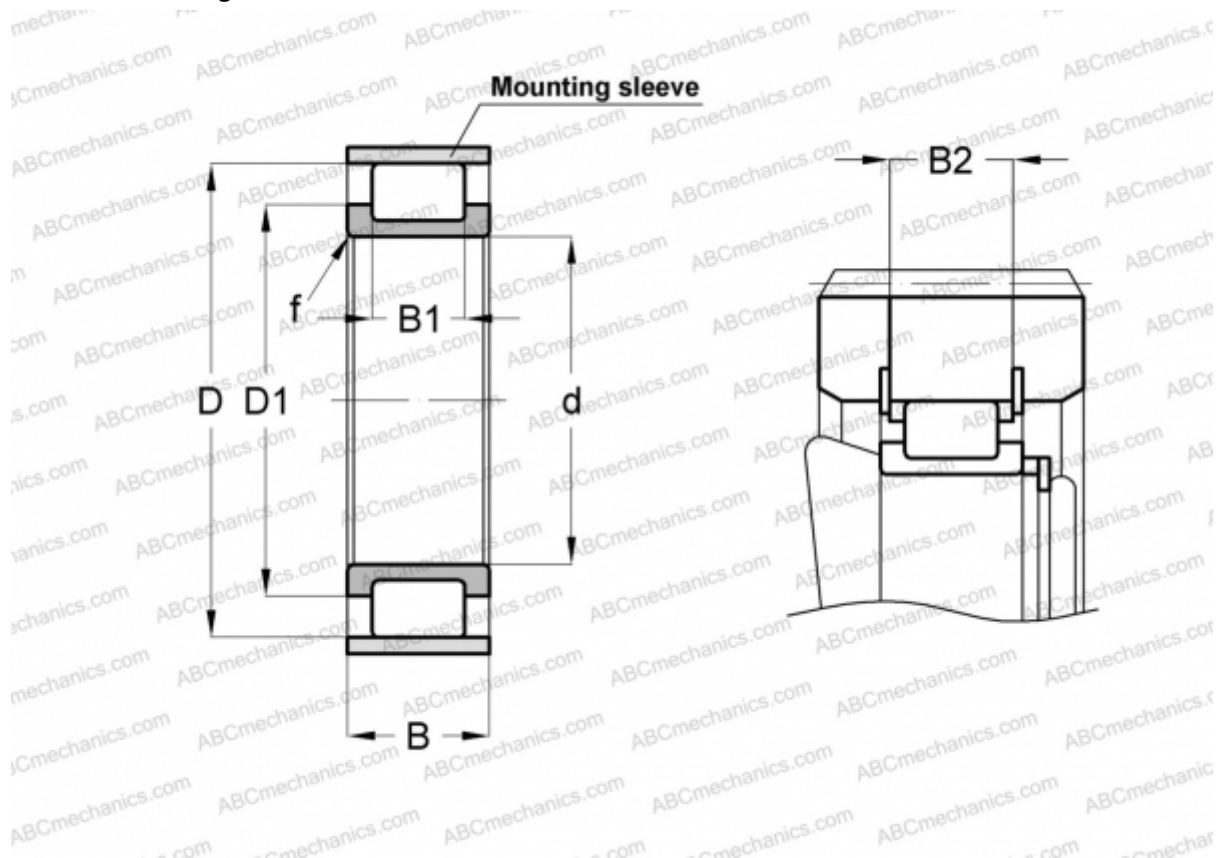

Technical specification

DIMENSIONS, MM

d	160,000
D	224,800
D1	185,000
B	60,000
B1	36,000
B2	54,400
f	2,100

WEIGHT, KG 5,820

MANUFACTURER [INA](#)

ASSOCIATED PRODUCTS

F-91814 + 225X5