

RSL182208-A INA

Cylindrical roller bearings

TYPE: Roller bearings, Cylindrical roller bearings, Single row, Without outer ring, Full complement cylindrical roller bearing

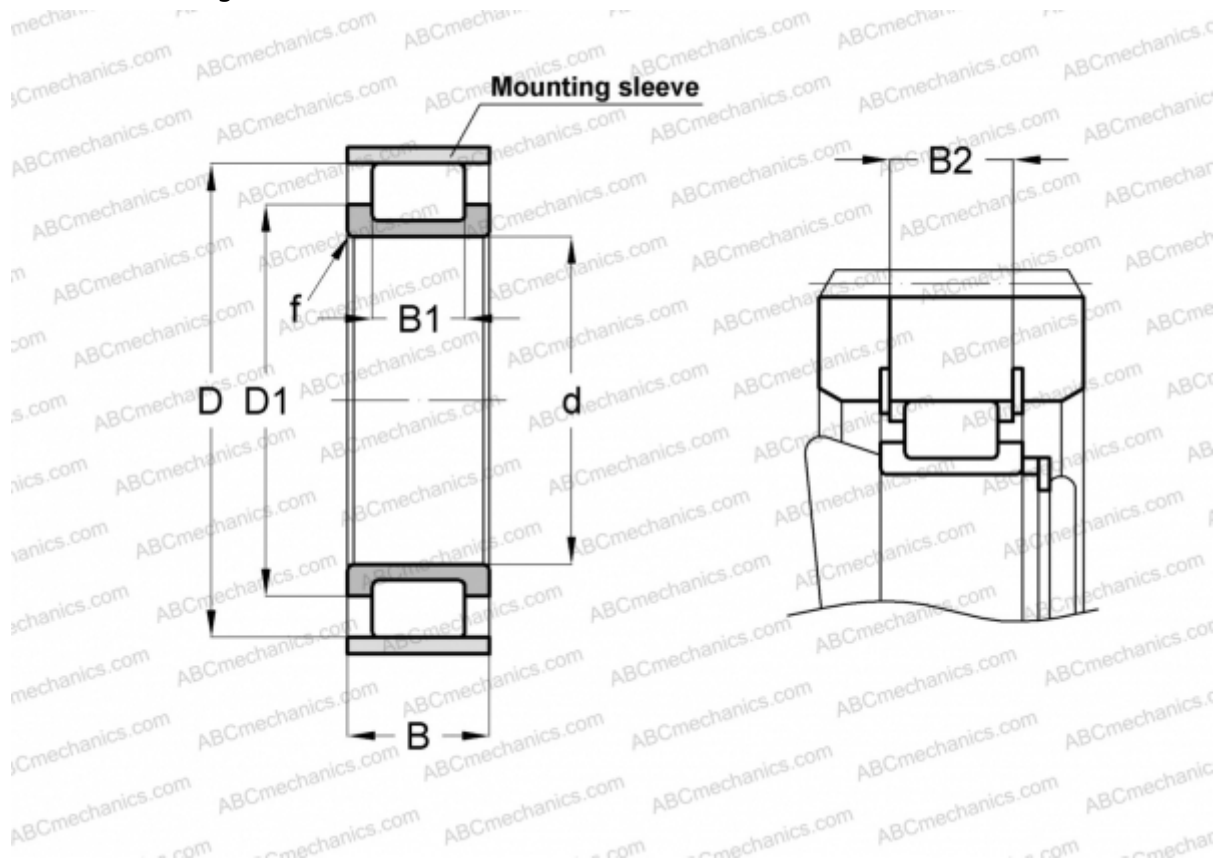

Technical specification

DIMENSIONS, MM

d	40,000
D	70,940
D1	54,000
B	23,000
B1	15,000
B2	20,200
f	1,100

WEIGHT, KG 0,340

MANUFACTURER [INA](#)

ASSOCIATED PRODUCTS

F-90397 + JV72