

RSL182209-A INA

Cylindrical roller bearings

TYPE: Roller bearings, Cylindrical roller bearings, Single row, Without outer ring, Full complement cylindrical roller bearing

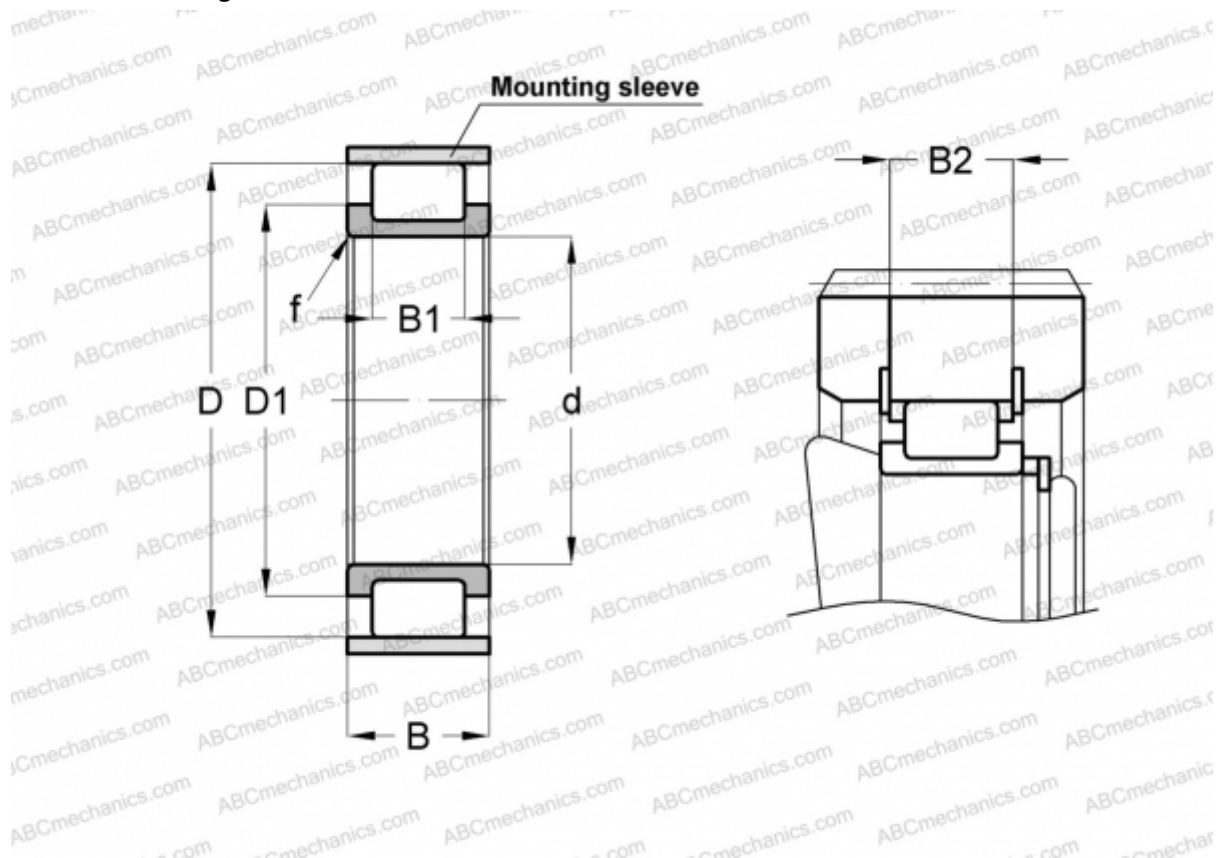

Technical specification

DIMENSIONS, MM

d	45,000
D	74,430
D1	57,500
B	23,000
B1	15,000
B2	20,200
f	1,100

WEIGHT, KG 0,340

MANUFACTURER [INA](#)

ASSOCIATED PRODUCTS

F-91914 + 75X2,5