

RSL182211-A INA

Cylindrical roller bearings

TYPE: Roller bearings, Cylindrical roller bearings, Single row, Without outer ring, Full complement cylindrical roller bearing

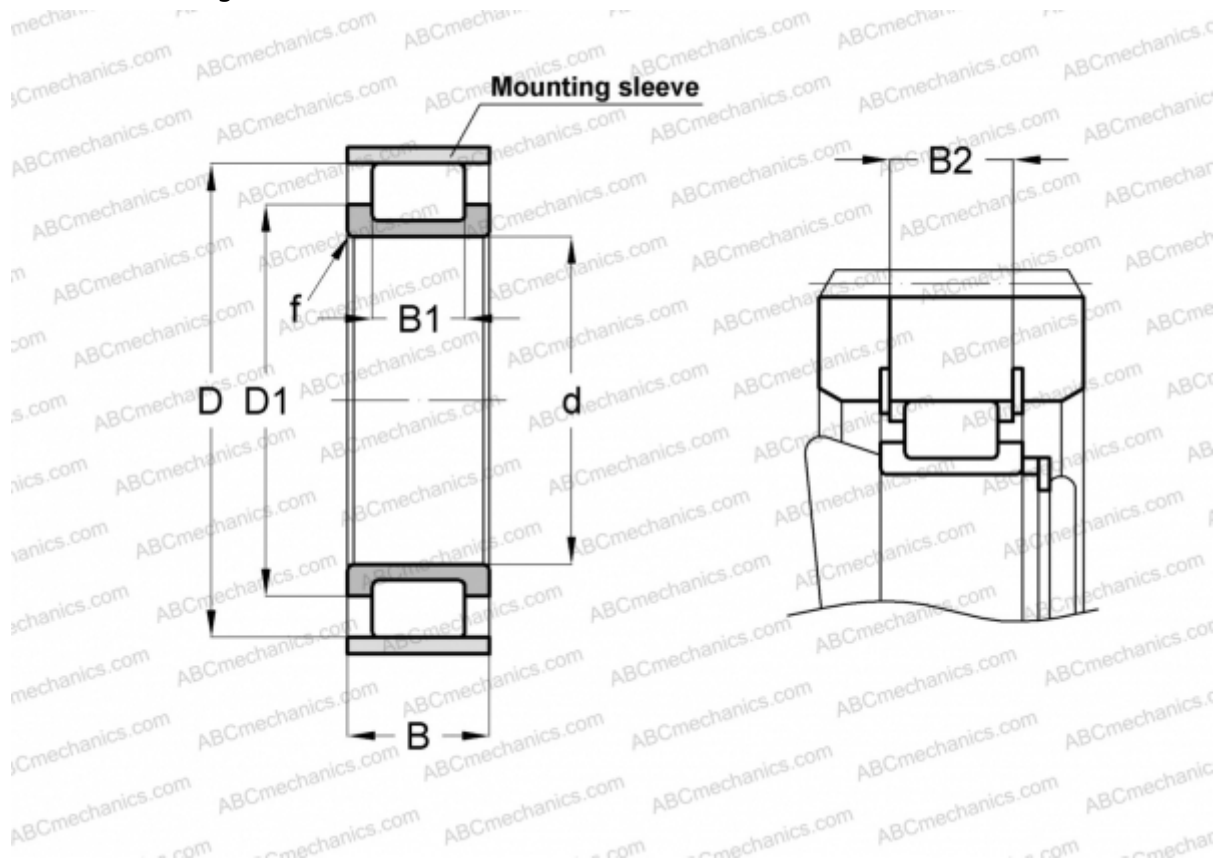

Technical specification

DIMENSIONS, MM

d	55,000
D	88,810
D1	70,000
B	25,000
B1	18,000
B2	21,600
f	1,500

WEIGHT, KG 0,540

MANUFACTURER [INA](#)

ASSOCIATED PRODUCTS

F-91915 + 88X3