

RSL182216-A INA

Cylindrical roller bearings

TYPE: Roller bearings, Cylindrical roller bearings, Single row, Without outer ring, Full complement cylindrical roller bearing

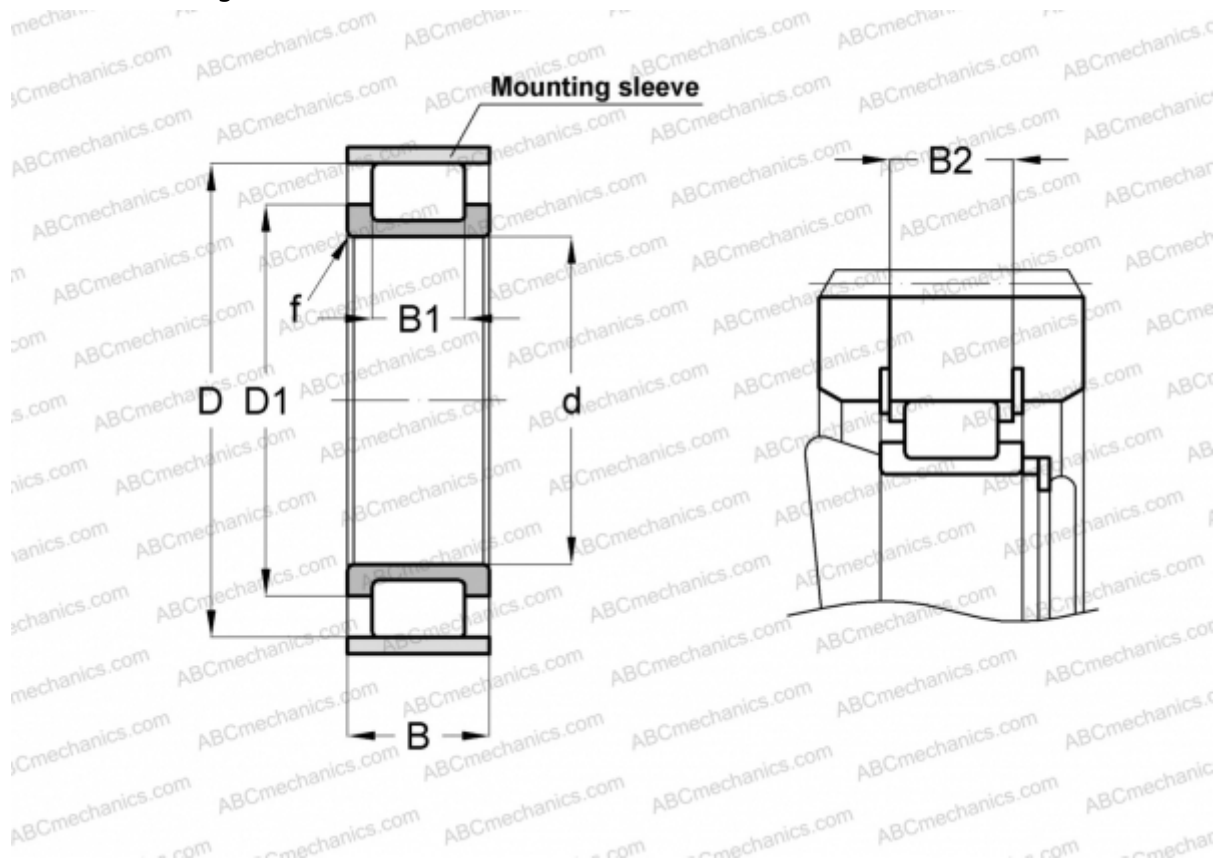

Technical specification

DIMENSIONS, MM

d	80,000
D	125,810
D1	98,500
B	33,000
B1	24,000
B2	28,500
f	2,000

WEIGHT, KG 1,330

MANUFACTURER [INA](#)

ASSOCIATED PRODUCTS

F-200908 + 125X4