

RSL182217-A INA

Cylindrical roller bearings

TYPE: Roller bearings, Cylindrical roller bearings, Single row, Without outer ring, Full complement cylindrical roller bearing

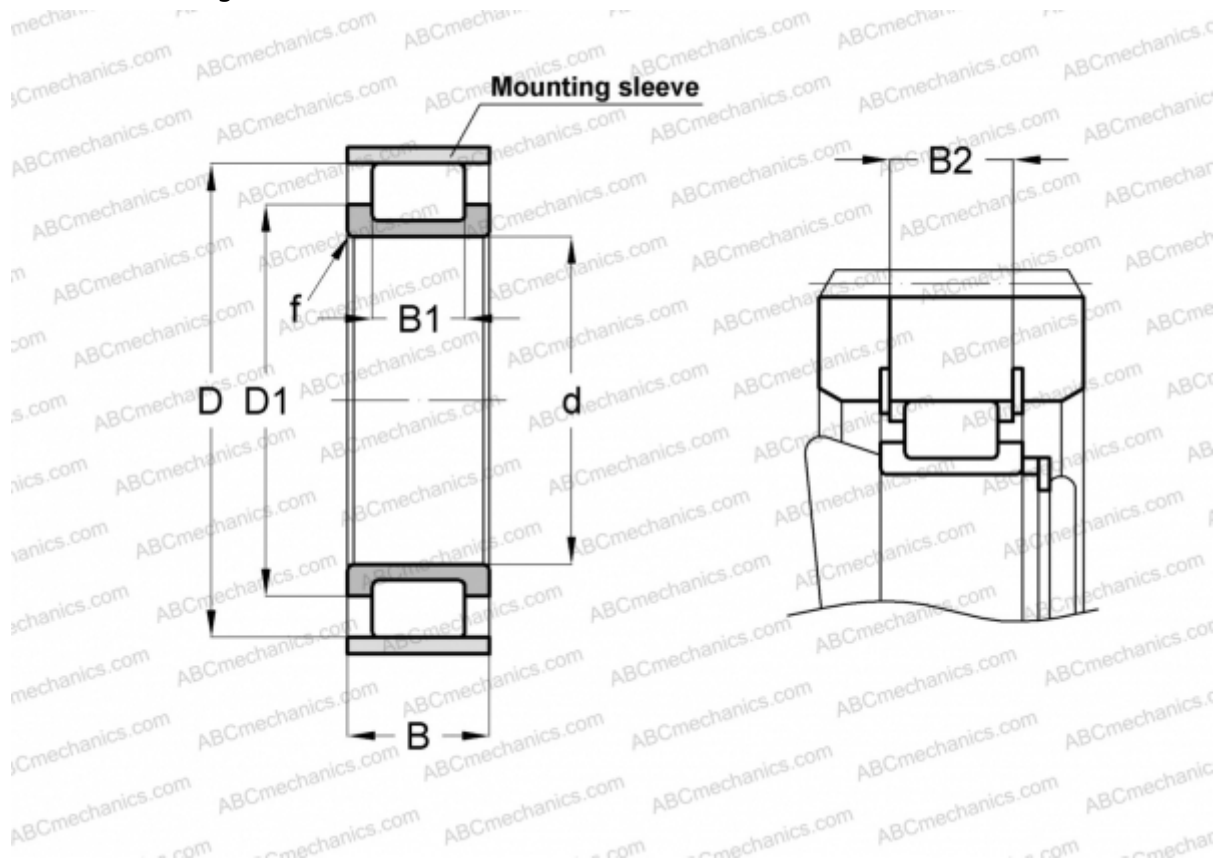

Technical specification

DIMENSIONS, MM

d	85,000
D	133,210
D1	104,500
B	36,000
B1	26,000
B2	31,500
f	2,000

WEIGHT, KG 1,610

MANUFACTURER [INA](#)

ASSOCIATED PRODUCTS

F-90401 + 132X4