

RSL182307-A INA

Cylindrical roller bearings

TYPE: Roller bearings, Cylindrical roller bearings, Single row, Without outer ring, Full complement cylindrical roller bearing

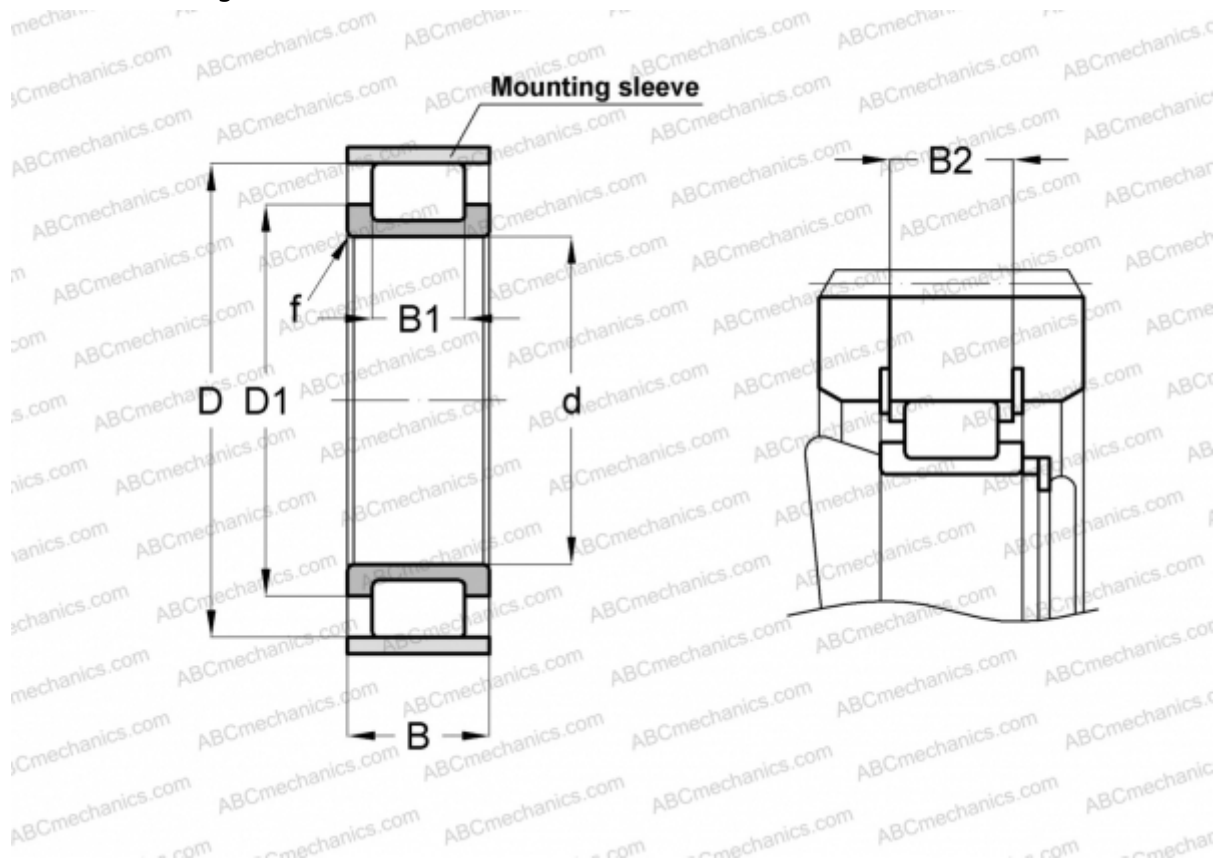

Technical specification

DIMENSIONS, MM

d	35,000
D	72,680
D1	51,000
B	31,000
B1	20,000
B2	28,200
f	1,500

WEIGHT, KG 0,500

MANUFACTURER [INA](#)

ASSOCIATED PRODUCTS

F-92061 + 72X2,5