

RSL182308-A INA

Cylindrical roller bearings

TYPE: Roller bearings, Cylindrical roller bearings, Single row, Without outer ring, Full complement cylindrical roller bearing

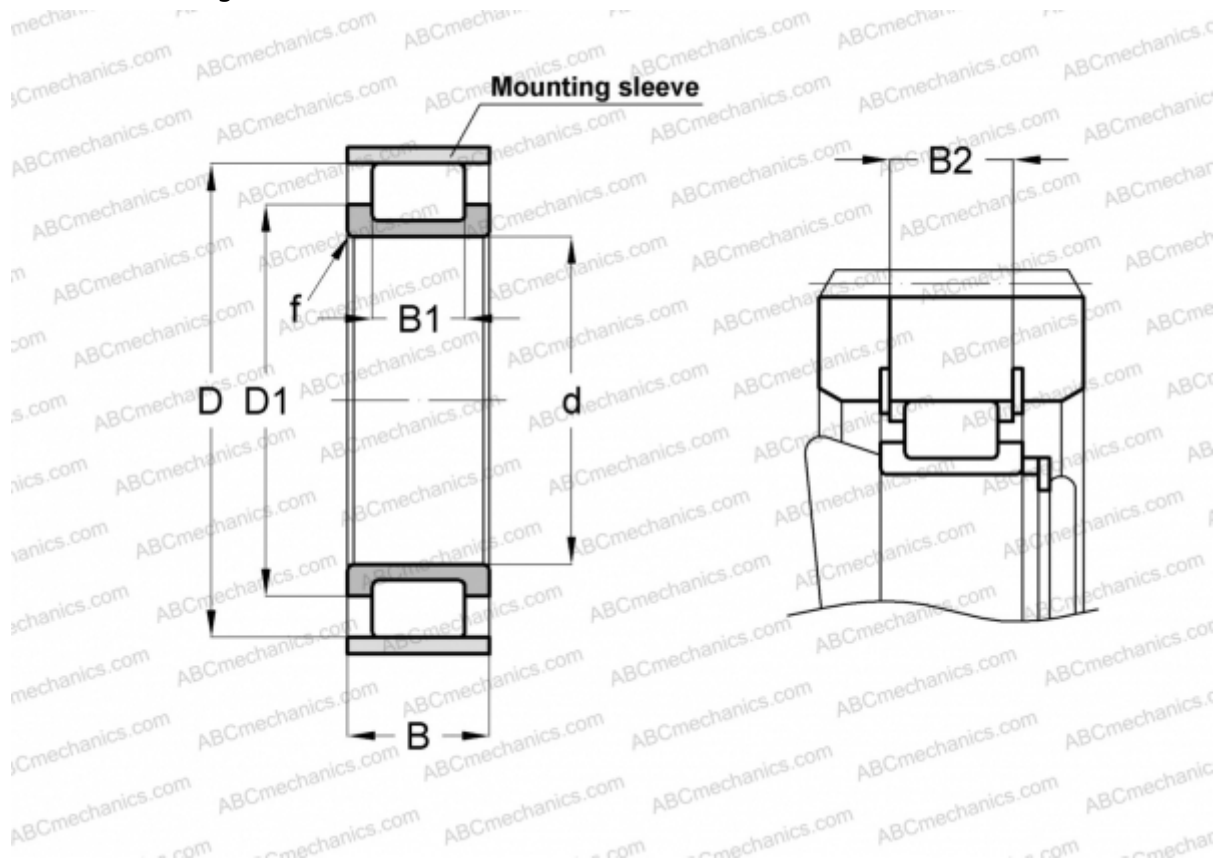

Technical specification

DIMENSIONS, MM

d	40,000
D	83,124
D1	58,000
B	33,000
B1	24,000
B2	30,200
f	1,500

WEIGHT, KG 0,740

MANUFACTURER [INA](#)

ASSOCIATED PRODUCTS

F-92062 + 82X2,5