

RSL182309-A INA

Cylindrical roller bearings

TYPE: Roller bearings, Cylindrical roller bearings, Single row, Without outer ring, Full complement cylindrical roller bearing

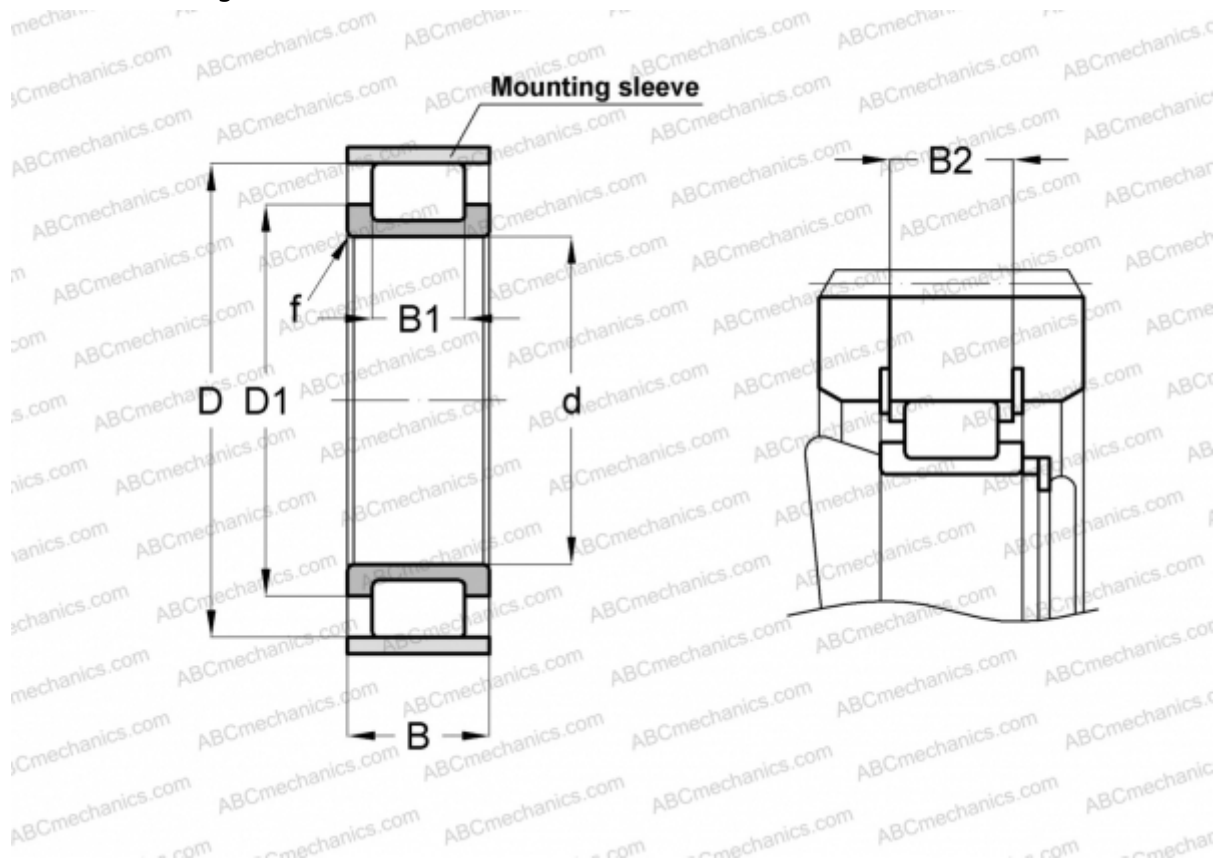

Technical specification

DIMENSIONS, MM

d	45,000
D	88,322
D1	61,500
B	36,000
B1	24,000
B2	32,600
f	1,500

WEIGHT, KG 0,840

MANUFACTURER [INA](#)

ASSOCIATED PRODUCTS

F-92063 + 88X3