

## RSL182311-A INA

Cylindrical roller bearings

TYPE: Roller bearings, Cylindrical roller bearings, Single row, Without outer ring, Full complement cylindrical roller bearing

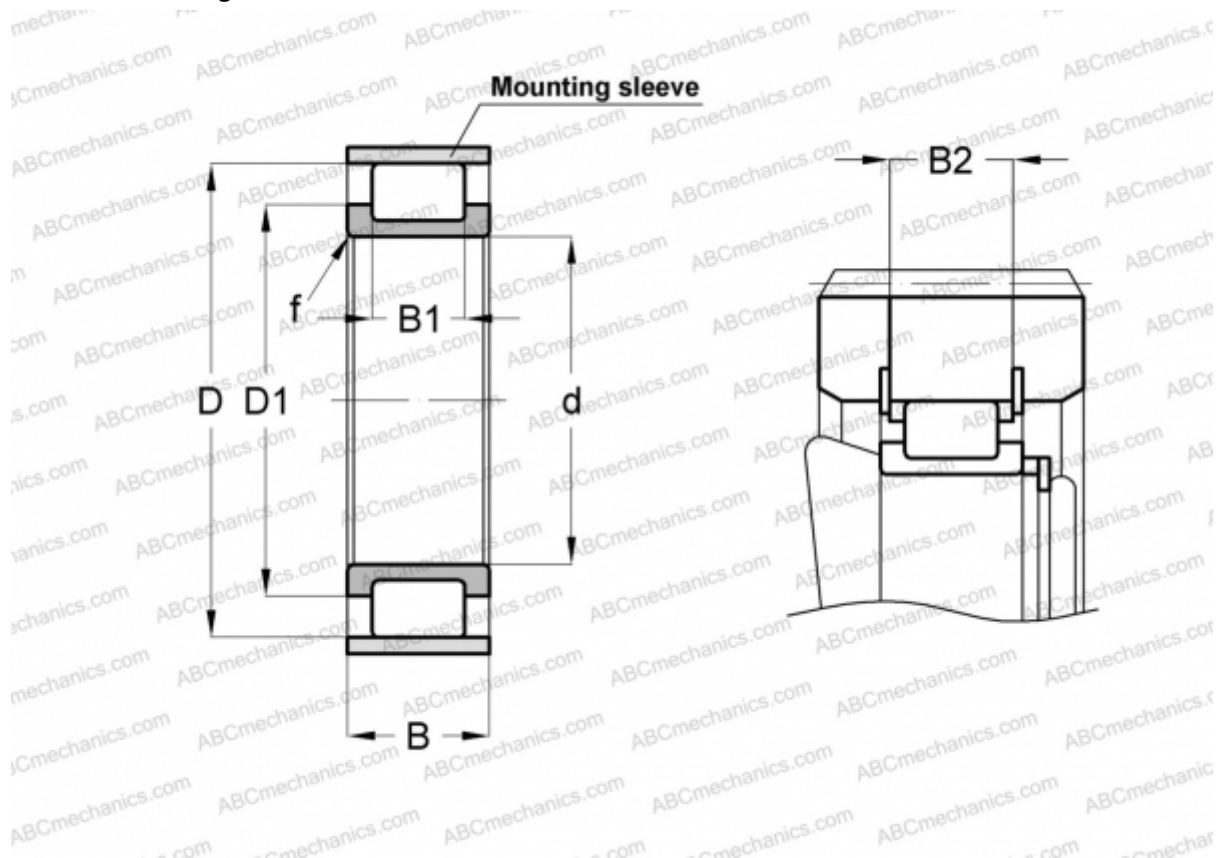

### Technical specification

#### DIMENSIONS, MM

d	55,000
D	109,110
D1	76,000
B	43,000
B1	30,000
B2	38,600
f	2,000

**WEIGHT, KG** 1,540

**MANUFACTURER** [INA](#)

#### ASSOCIATED PRODUCTS

F-92065 + 110X4