

RSL182315-A INA

Cylindrical roller bearings

TYPE: Roller bearings, Cylindrical roller bearings, Single row, Without outer ring, Full complement cylindrical roller bearing

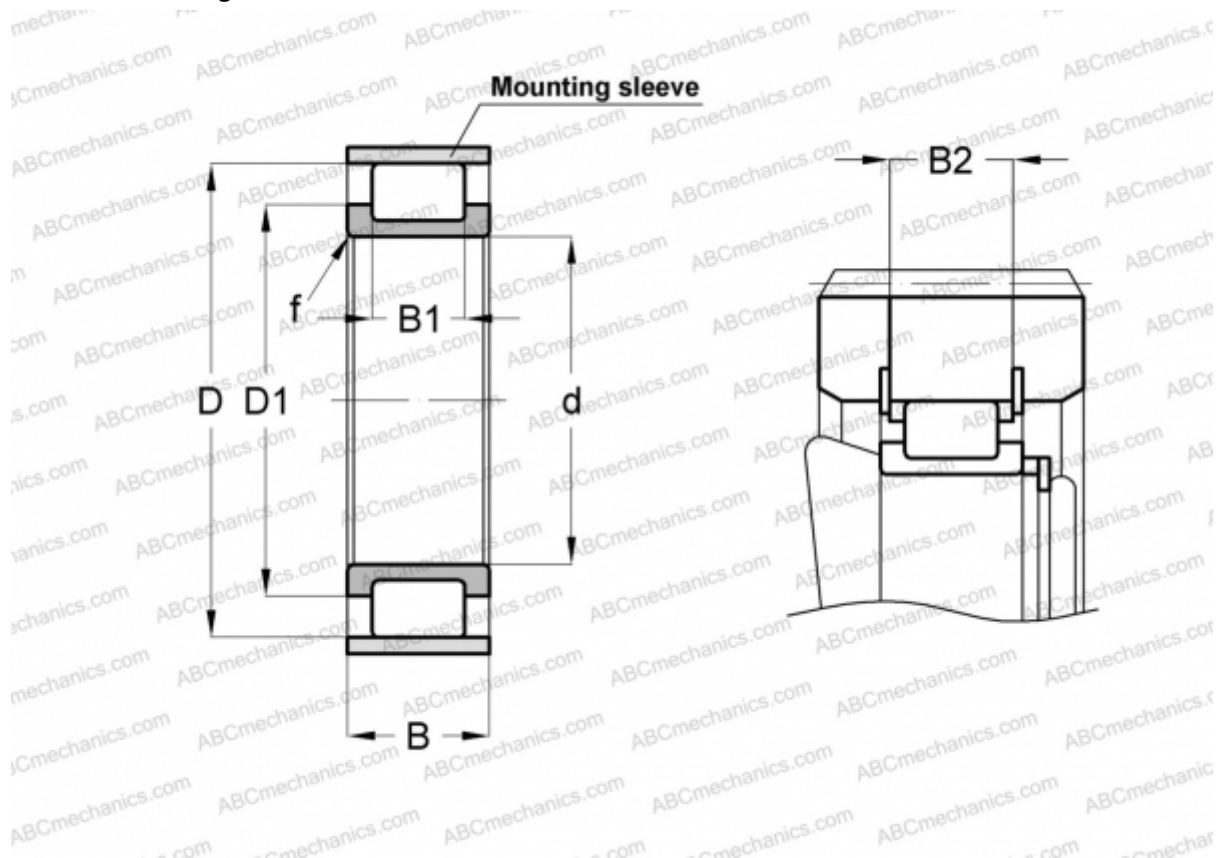

Technical specification

DIMENSIONS, MM

d	75,000
D	143,220
D1	102,000
B	55,000
B1	40,000
B2	50,600
f	2,100

WEIGHT, KG 3,430

MANUFACTURER [INA](#)

ASSOCIATED PRODUCTS

F-92069 + 145X4