

RSL182317-A INA

Cylindrical roller bearings

TYPE: Roller bearings, Cylindrical roller bearings, Single row, Without outer ring, Full complement cylindrical roller bearing

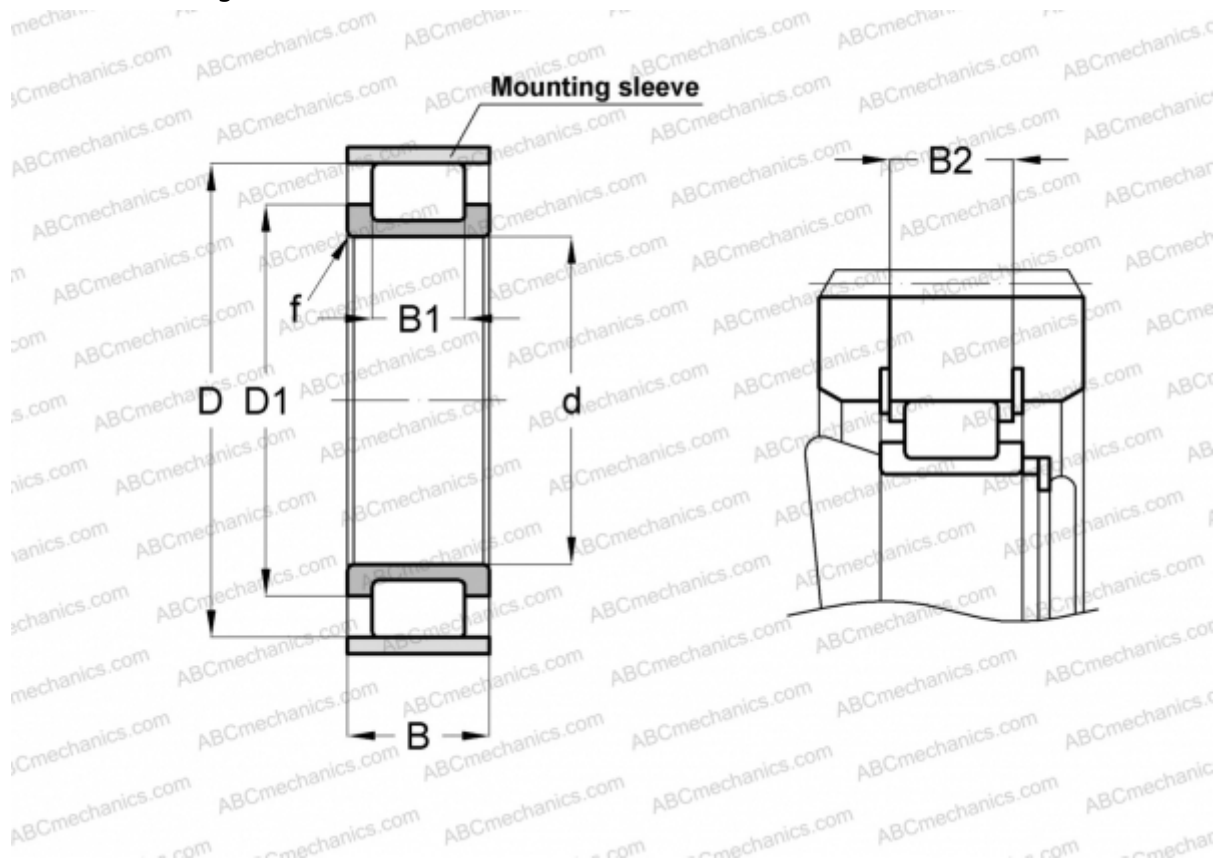

Technical specification

DIMENSIONS, MM

d	85,000
D	163,010
D1	118,500
B	60,000
B1	44,000
B2	55,600
f	3,000

WEIGHT, KG 4,580

MANUFACTURER [INA](#)

ASSOCIATED PRODUCTS

F-92071 + 165X4