

RN209-E-MPBX INA

Cylindrical roller bearings

TYPE: Roller bearings, Cylindrical roller bearings, Single row, Without outer ring, With cage

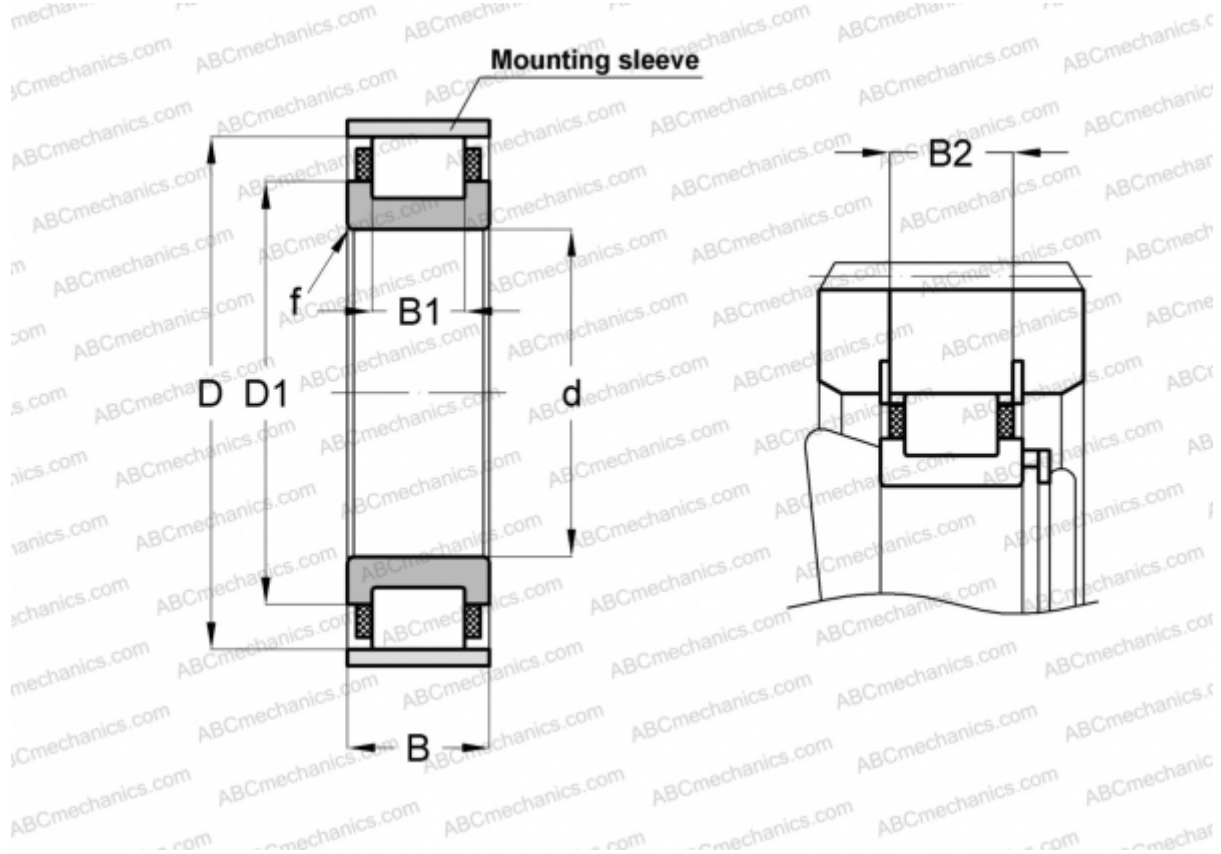

Technical specification

DIMENSIONS, MM

d	45,000
D	76,500
D1	59,000
B	19,000
B1	12,000
B2	16,700
f	1,100

WEIGHT, KG 0,320

MANUFACTURER [INA](#)

ASSOCIATED PRODUCTS

SB76 2X2,8