

RN308-E-MPBX INA

Cylindrical roller bearings

TYPE: Roller bearings, Cylindrical roller bearings, Single row, Without outer ring, With cage

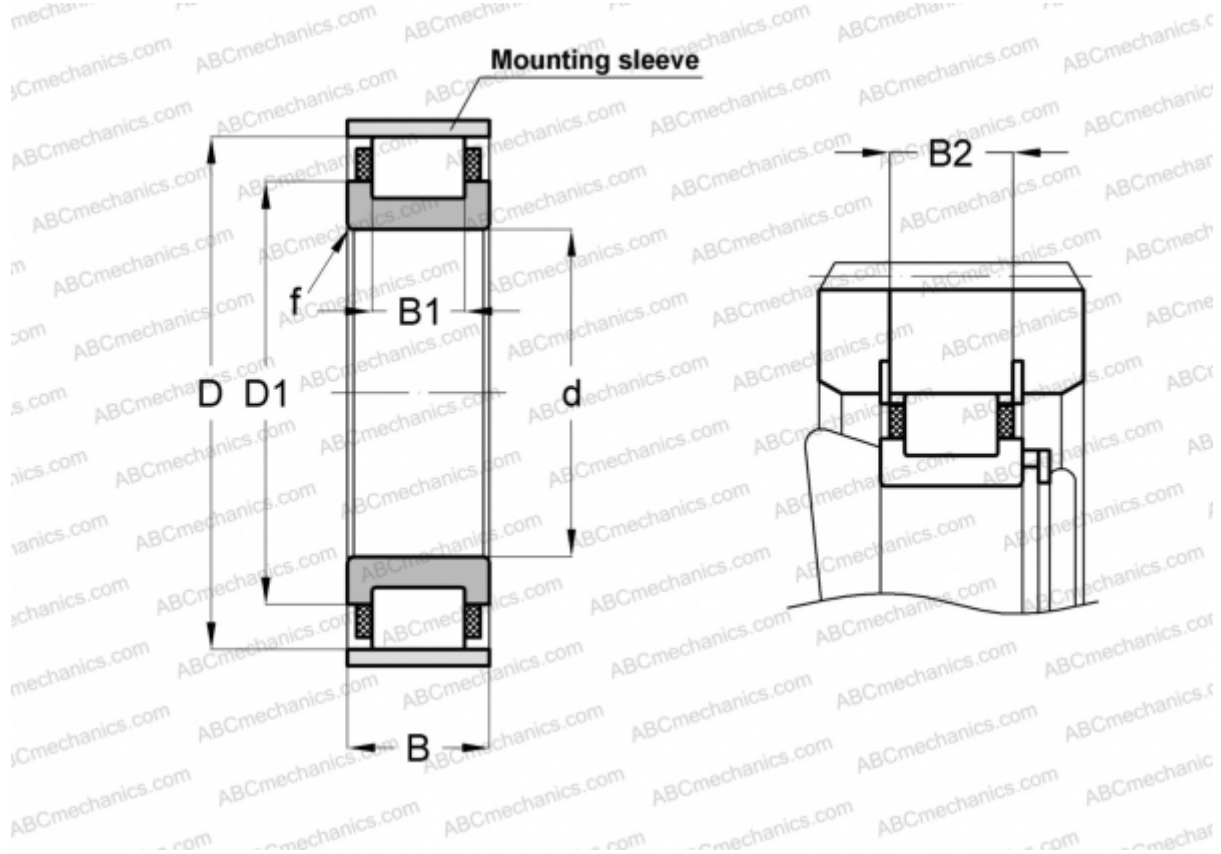

Technical specification

DIMENSIONS, MM

d	40,000
D	80,000
D1	57,600
B	23,000
B1	15,000
B2	20,700
f	1,500

WEIGHT, KG 0,480

MANUFACTURER [INA](#)

ASSOCIATED PRODUCTS

SB80 2X2,8