

RN310-E-MPBX INA

Cylindrical roller bearings

TYPE: Roller bearings, Cylindrical roller bearings, Single row, Without outer ring, With cage

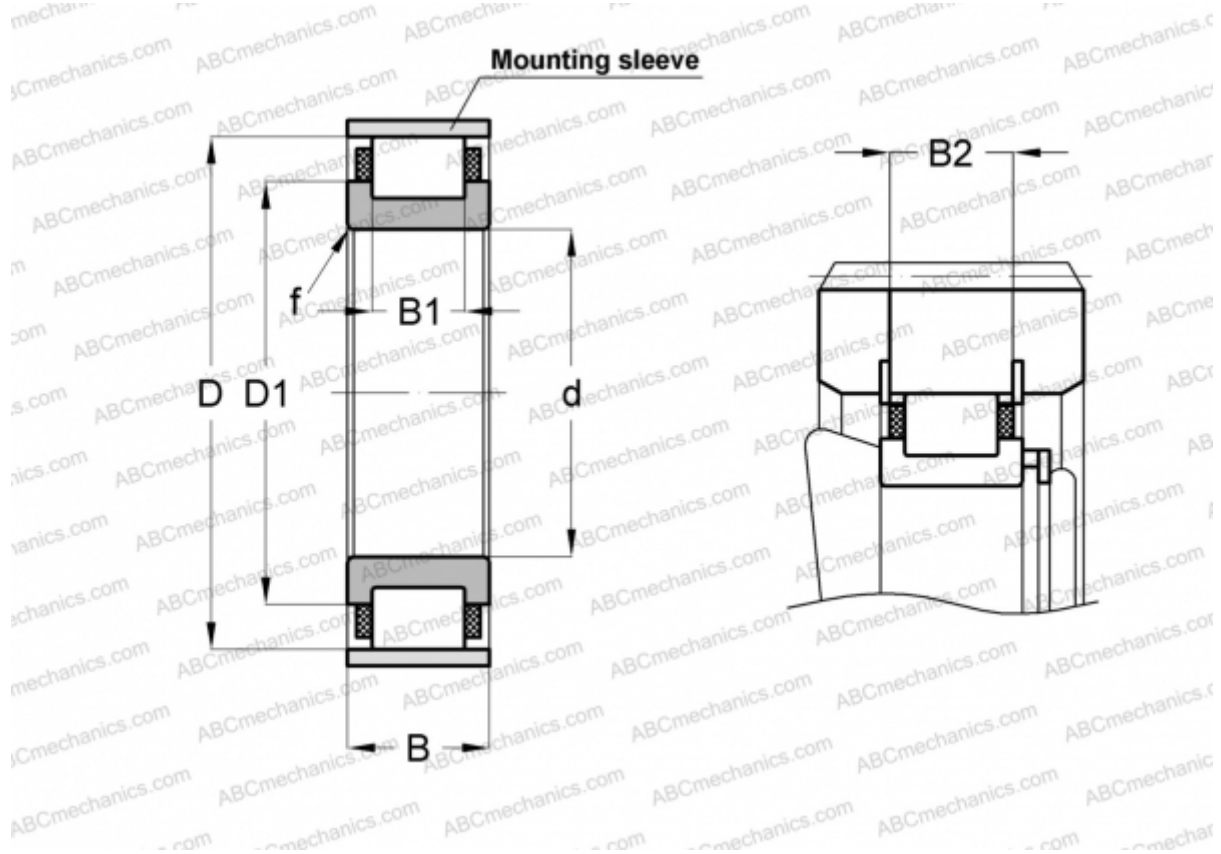

Technical specification

DIMENSIONS, MM

d	50,000
D	97,000
D1	71,300
B	27,000
B1	17,000
B2	24,200
f	2,000

WEIGHT, KG 0,810

MANUFACTURER [INA](#)

ASSOCIATED PRODUCTS

SB97 2,5X3,4