

RN311-E-MPBX INA

Cylindrical roller bearings

TYPE: Roller bearings, Cylindrical roller bearings, Single row, Without outer ring, With cage

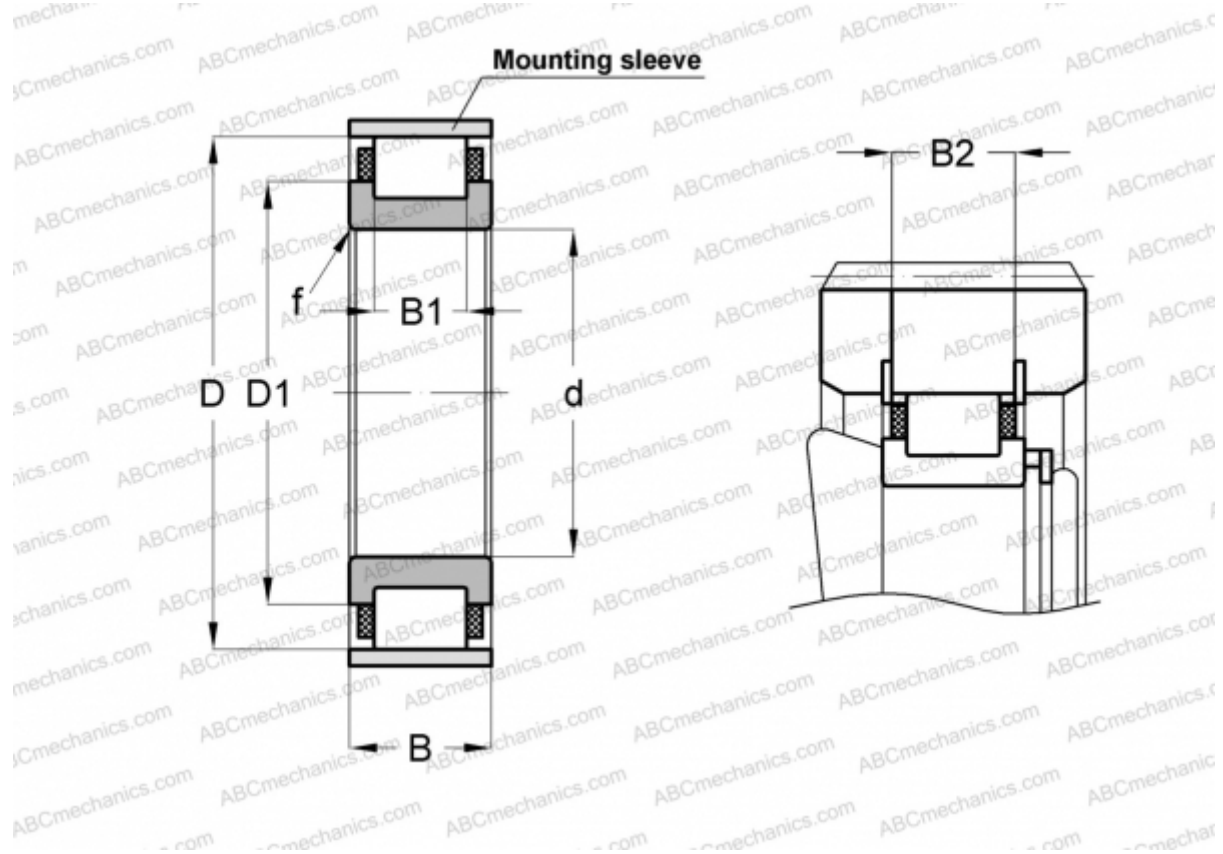

Technical specification

DIMENSIONS, MM

d	55,000
D	106,500
D1	77,500
B	29,000
B1	19,000
B2	26,200
f	2,000

WEIGHT, KG 1,060

MANUFACTURER [INA](#)

ASSOCIATED PRODUCTS

SB107 2,5X3,4